

 Roland

Polyphonic

Guitar Synthesizer

GR-300 OWNER'S MANUAL

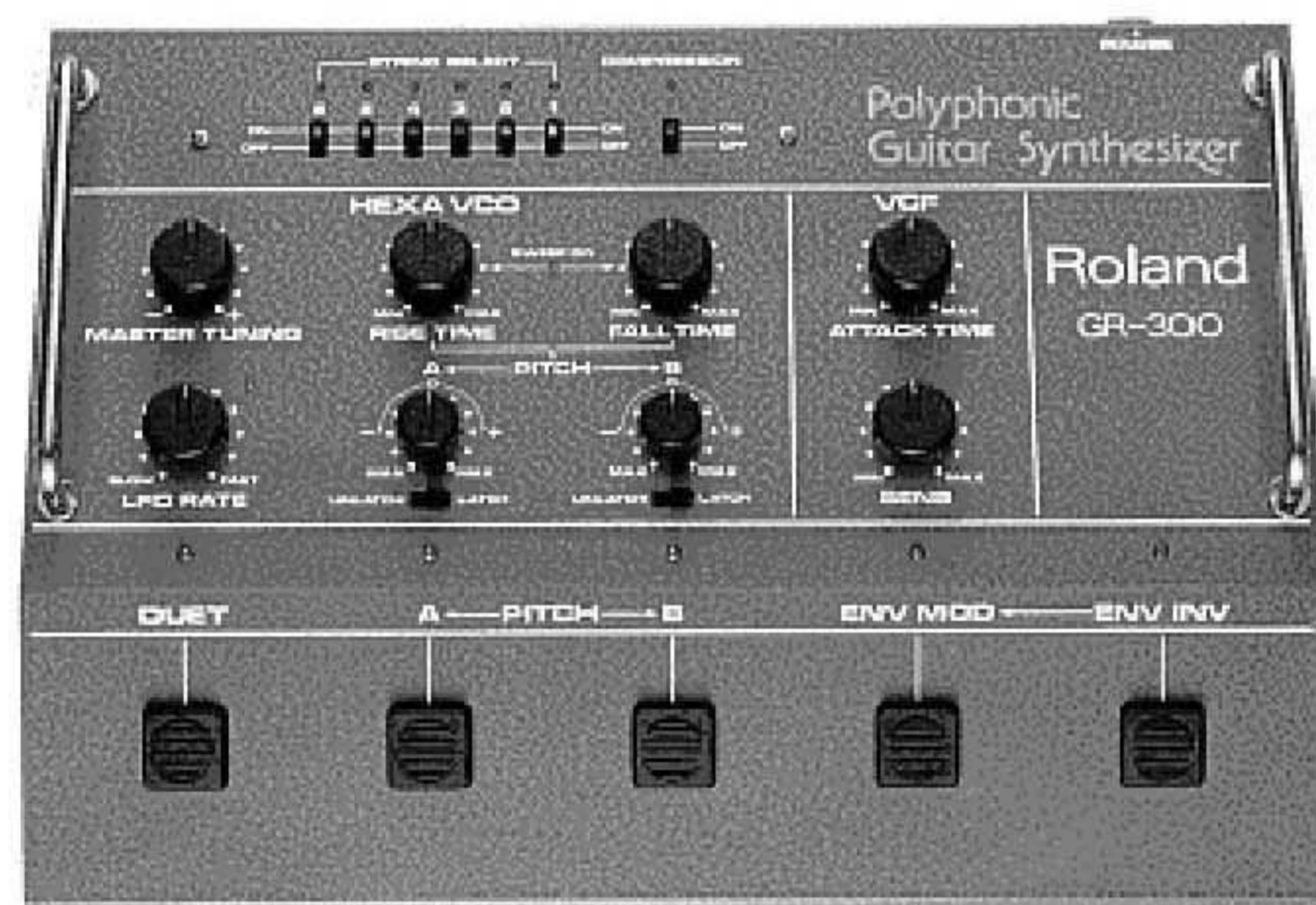

Guitar Synthesizer

FEATURES

Any guitarist can play the GR-300, using all standard guitar playing techniques, including: hammering, glissandos, harmonics, chopping, etc.

The GR-300 produces effects and nuances which keyboard synthesizers cannot easily produce.

To produce the effect of the GR-300, you would need:

6-octave shifters + 6-compressors + 6-chorus machines + 6-distortion units + 6-phase shifters + waw + etc. + etc.

It is very easy to produce anything from simple or complex solo sounds to the sounds of a huge band or orchestra. All major functions are controlled with foot switches and require no hands.

- Small, compact unit (like an effects box) with all electronic-type foot-controlled switching of major functions; good for live performance.
- Produces stable effects for all styles of guitar playing which, up to now, were impossible: hammering, glissando, chopping, etc.
- Totally polyphonic: one VCO for each string.
- Instant and accurate transposing to two preset pitches.
- Duet switch for chorus effect.
- Polyphonic distortion for new clarity, even with chords.
- Synthesizer ON/OFF for each string.

INDEX

STANDARD CONNECTIONS

MIXED OUTPUT3

GUITAR SYNTHESIZER OUTPUT3

BASIC SETTING4

PRODUCING SOUND5

■ VCF5

■ COMPRESSION6

■ VCO VIBRATO7

■ PITCH SHIFT7

■ STRING SELECTOR9

■ HEXA DISTORTION9

USING ATTACHMENTS10

SAMPLE SOUNDS11 ~ 13

SAMPLE NOTES14 ~ 18

SPECIFICATIONS19

OPTIONAL ACCESSORIES19

Before Starting

- Use a transformer to produce the correct line voltage if the line voltage in your area does not match the value specified on the name plate.
- Keep away from fluorescent lamps, neon lights, and high-power transformers as these will produce high noise levels in the Guitar Synthesizer.
- Avoid the use of this instrument in places that are dusty, of high temperature or high humidity.
- Clean the control panel with neutral detergent. Use a soft, dry cloth for the wooden parts. Do not use solvents such as paint thinner.
- The GR-300 Guitar Synthesizer has been designed to work with the G-303 or G-808 Guitar Controller and will not work with the GR-500 Guitar Controller.
- The length of the sound may be shorter than normal, or the synthesized sound may be one octave higher than normal with certain styles of picking and stopping the strings.

STANDARD CONNECTIONS

GUITAR CONNECTIONS

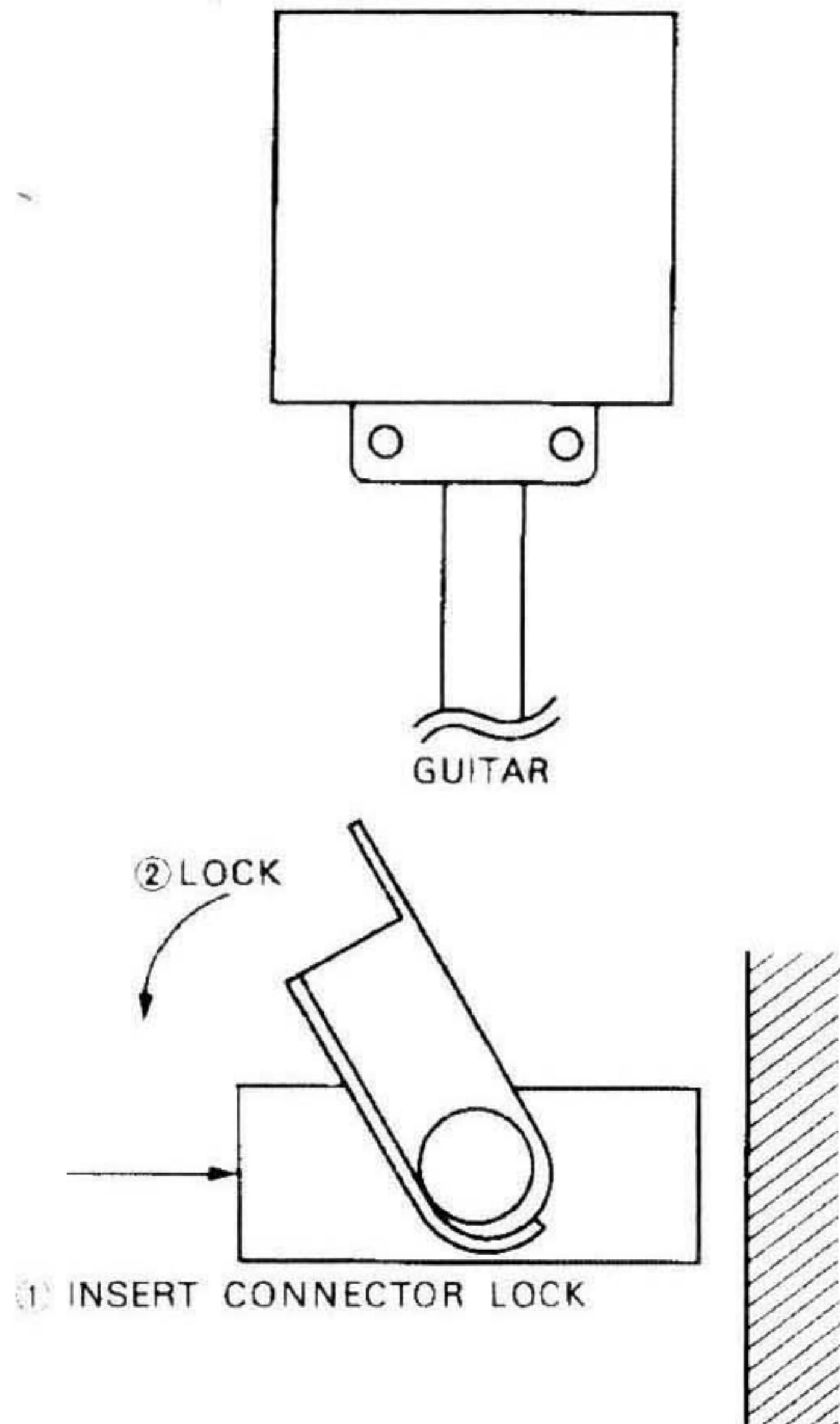

Connect the G-303 or G-808 as shown in the drawing using the chrome guitar connector. The connector is keyed and must be inserted correctly (lock lever up) for a proper fit. (The NORMAL OUTPUT jack on the Guitar Controller is not connected to the Guitar Synthesizer.)

MIXED OUTPUT USING ONE AMPLIFIER

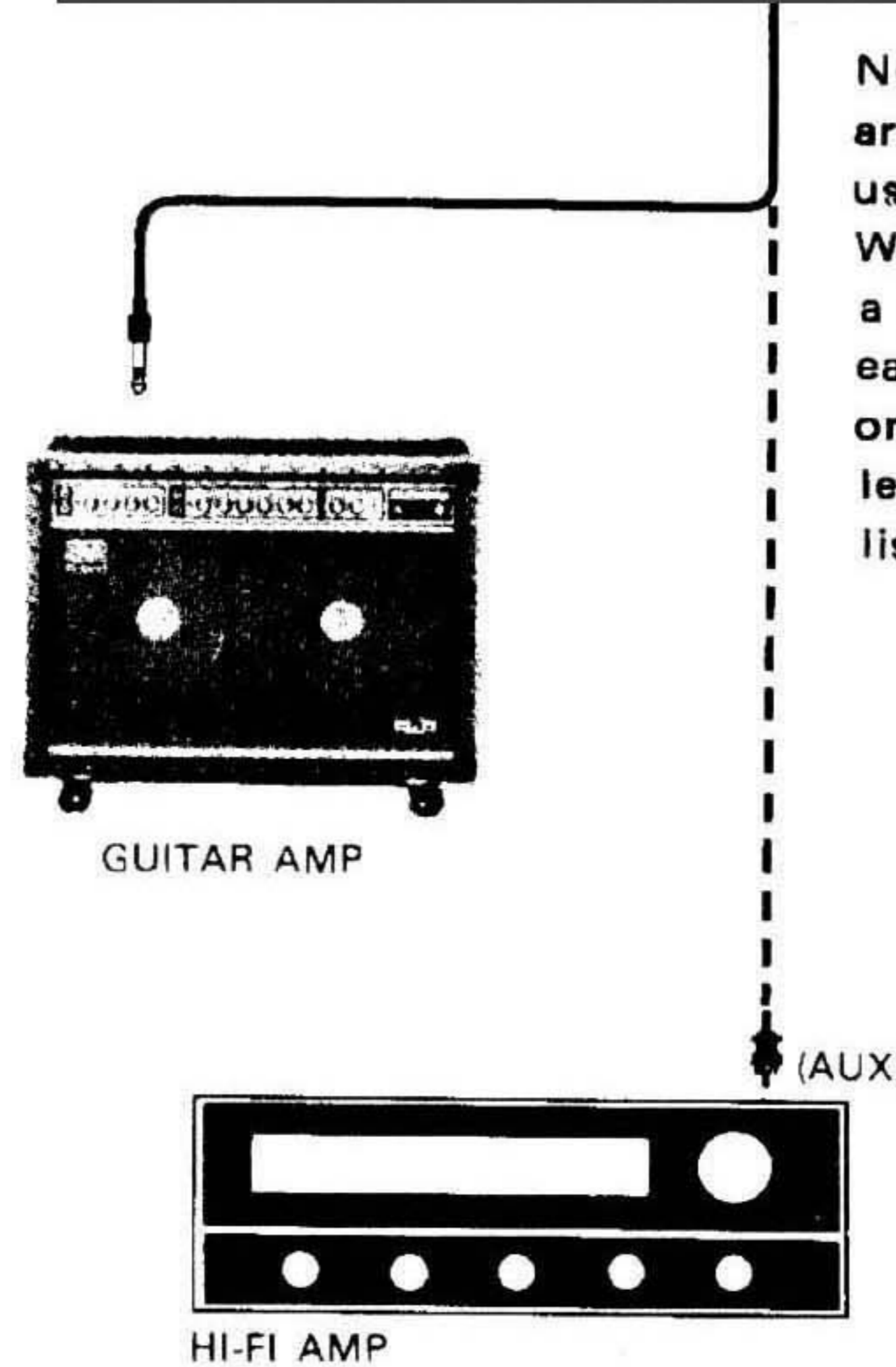

Note: The GR-300 outputs are set at guitar level for use with guitar amplifiers. When using the AUX IN of a hi-fi type amplifier, a pre-amp may be necessary in order to bring the sound level up to the desired listening level.

When there is no connection to the GUITAR OUTPUT jack on the rear panel of the Guitar Synthesizer, the output at the MIX/SYNTH jack consists of an equal mixture of the guitar and synthesizer sounds.

GUITAR SYNTHESIZER OUTPUT USING TWO AMPLIFIERS

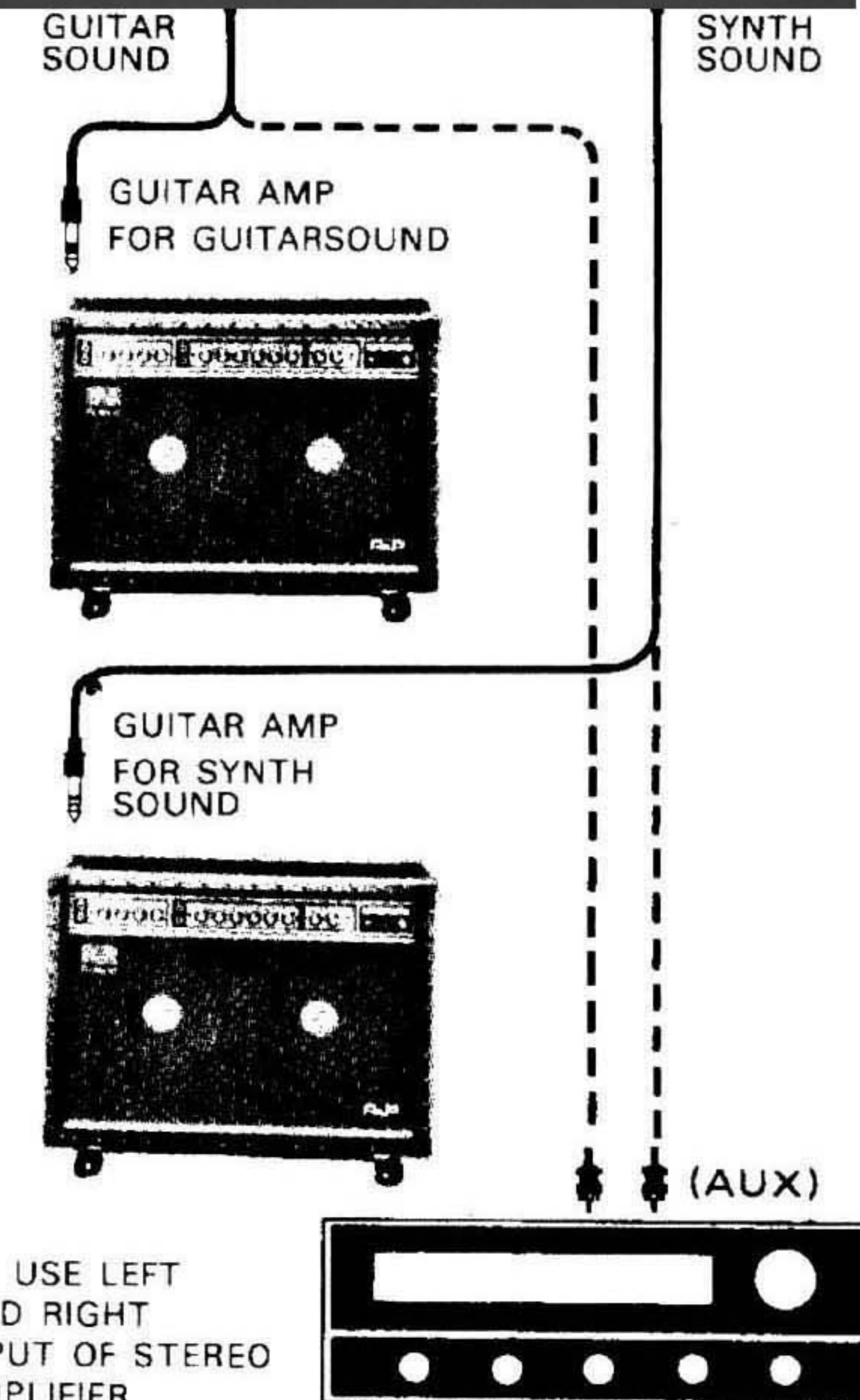

OR USE LEFT AND RIGHT INPUT OF STEREO AMPLIFIER

When both output jacks are used, the outputs are separated with the guitar sound at the OUTPUT jack and the synthesizer sound at the MIX/SYNTH jack. These separate outputs can be passed through separate effects devices and amplifiers for stereo sound.

STANDARD SETTING

GS-303/808

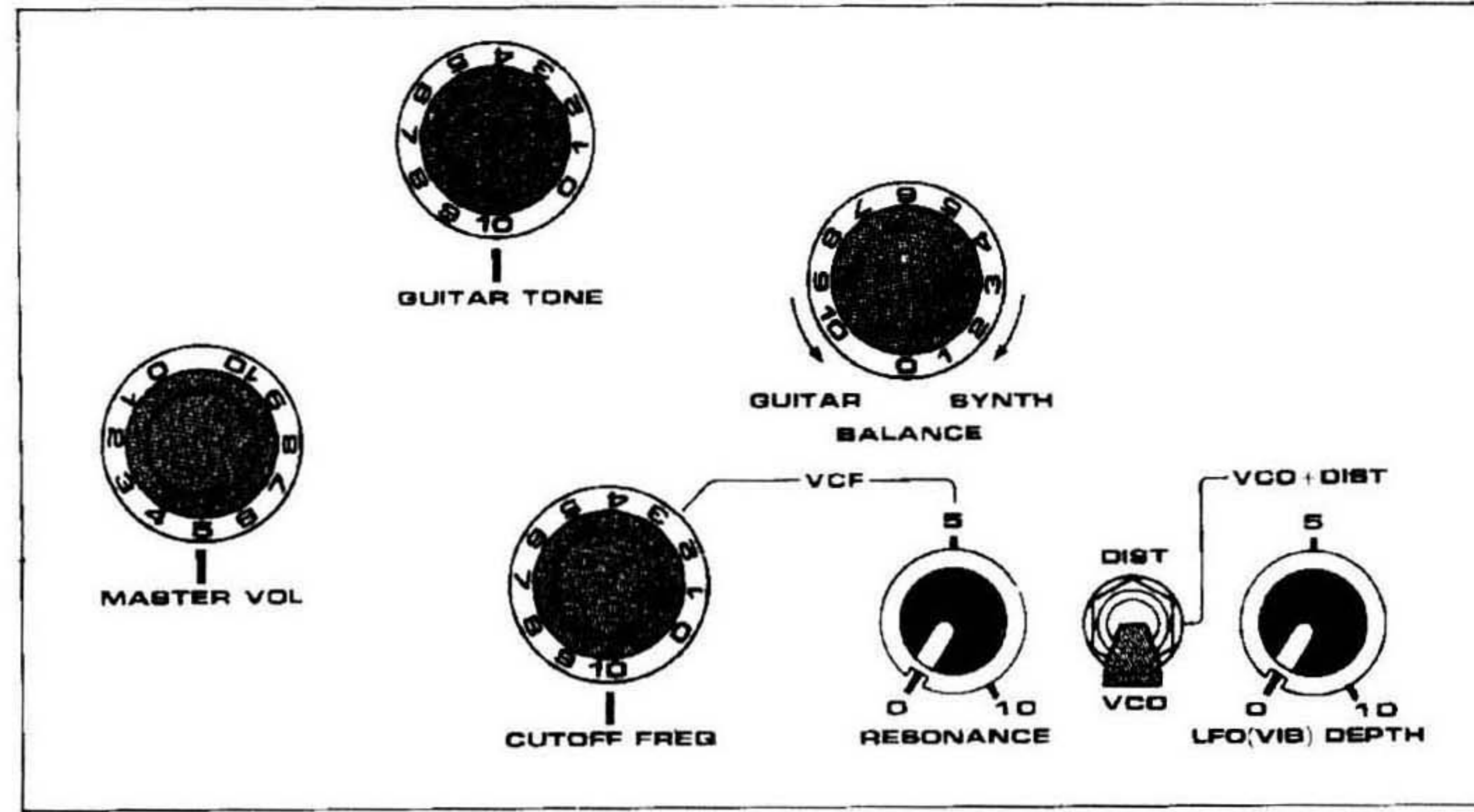

GR-300

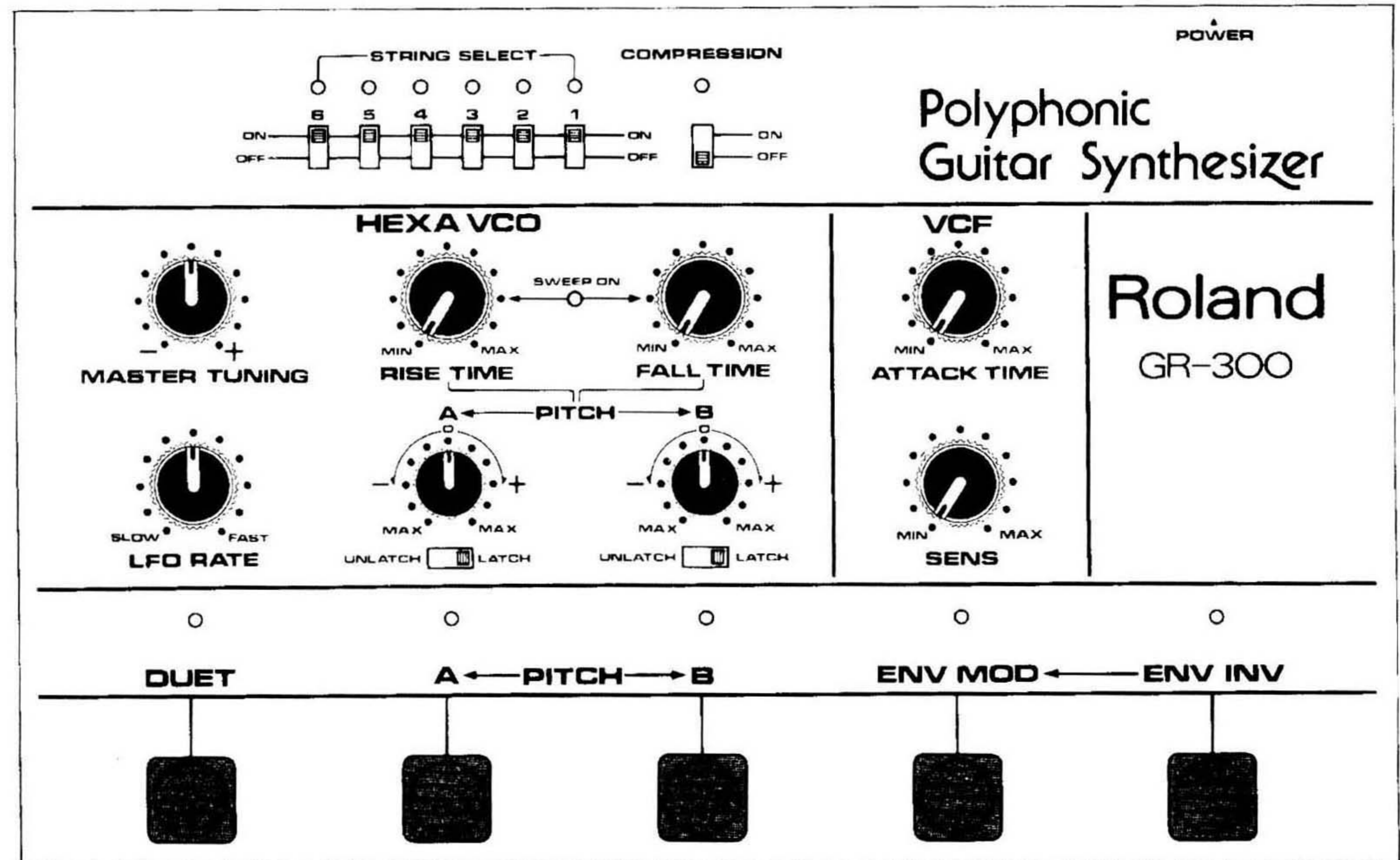

PRODUCING SOUND

Set the controls as shown on the left. Set the external amplifier volume at minimum and turn on all the power switches. Turn up the volume control; playing the guitar should produce the guitar sound. If needed, tune the Guitar Controller in exactly the same way as an ordinary electric guitar is tuned.

To produce the synthesizer sound, turn the BALANCE control fully clockwise (to "10"). This control determines the balance between the guitar and synthesizer sounds. For the moment, leave it at "10".

The sound produced now is the unprocessed sound from the synthesizer VCO's (voltage controlled oscillators). Press the DUET foot switch. The DUET switch adds the fundamental pitches of the guitar strings to the VCO sounds to produce a chorus effect. It is necessary to tune the VCO's so that they match the pitches of the strings by using the MASTER TUNING control. For accurate tuning, use as high a guitar pitch as possible and allow at least ten minutes for a warm-up period after first turning on the power switch.

USING THE VCF

Let's try the VCF (voltage controlled filter) section next. While producing sound as described above, try slowly lowering the Guitar Controller VCF CUTOFF FREQ control to "0". Note that the sound becomes softer with fewer harmonics. The purpose of the VCF is to control the tone color of the synthesizer sound.

Next, raise the Guitar Controller RESONANCE control a little at a time while trying different positions of the CUTOFF FREQ control. This produces an electronic type of sound usually associated with synthesizers. The two controls, CUTOFF FREQ and RESONANCE, combine to control the tone color of the sound passing through the VCF.

Raise the VCF SENS (sensitivity) control to maximum. Set the RESONANCE control at "5" and the CUTOFF FREQ control at "3". While repeatedly picking a string, try pressing the ENV MOD (envelope modulation) foot switch. In this mode of operation, the filtering action of the VCF is controlled by the picking of the guitar strings instead of manually, as before, to produce a "wow" sound. This is called **envelope modulation**.

Try raising the ATTACK TIME control. This causes the rising (attack time) of the "wow" sound to become longer.

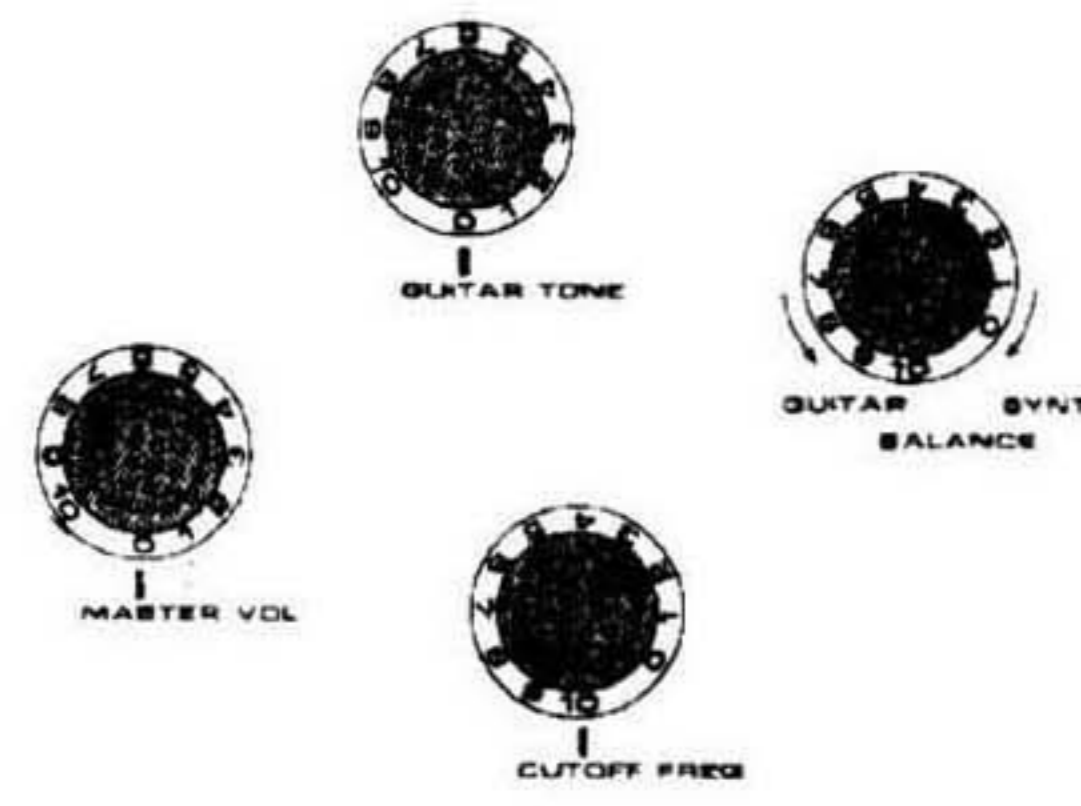

DUET



DUET SWITCH ADDS THE FUNDAMENTAL PITCHES OF THE GUITAR STRINGS TO VCO



MASTER TUNING

TUNES VCO'S

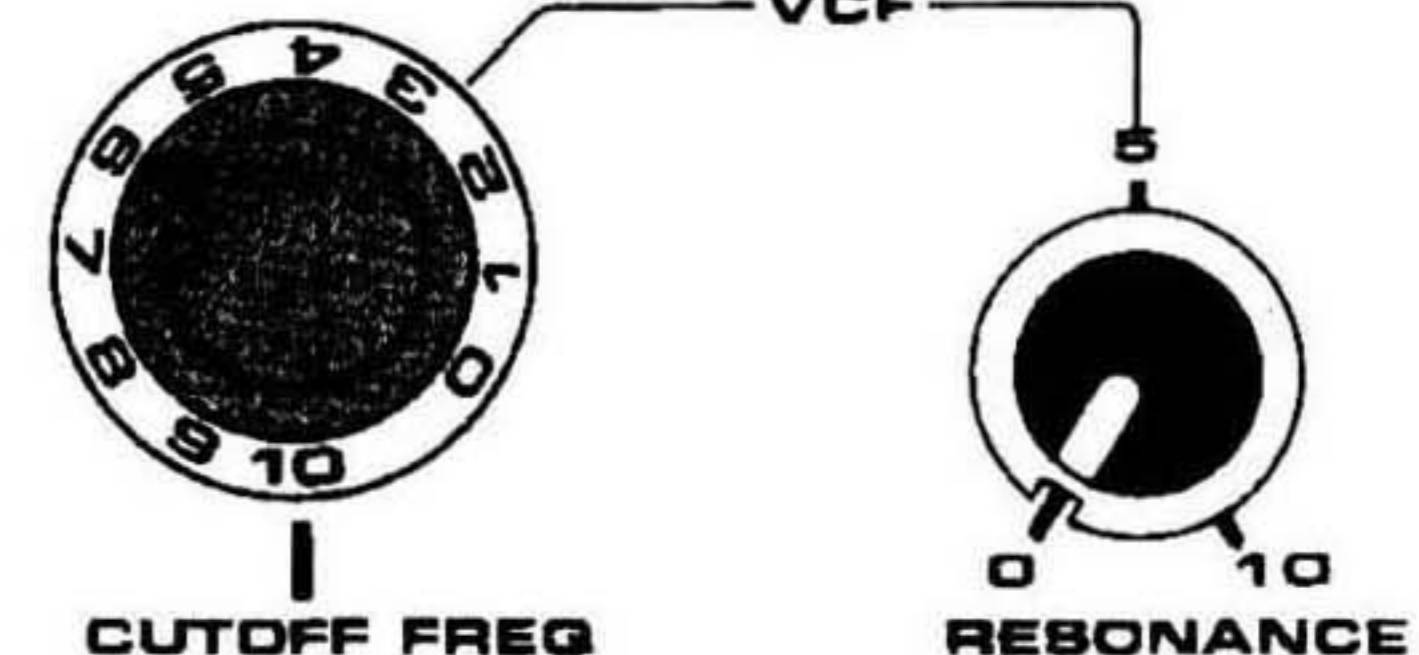

CUTOFF FREQ **RESONANCE**

If a foot volume pedal (Roland FV-20; sold separately) is connected to the VCF PEDAL jack on the rear panel of the VCF, the VCF cutoff frequency (in other words, the tone color of the output sound) can be controlled manually with your foot.



VCF PEDAL

To review:

The ENV MOD (envelope modulation) foot switch turns the "WOW" effect on and off.

The SENS (sensitivity) knob controls the depth of the "wow" effect.

The ATTACK TIME knob controls the time required for the rising part of the "wow" sound.

The CUTOFF FREQ knob controls the tone color of the sound manually and is used to set the initial tone color value. When the ENV MOD mode is used, the tone color is swept up, then back down to the initial tone color. If the CUTOFF FREQ knob is at "10", the initial tone color will be bright, but since the tone color control is already at maximum, the ENV MOD mode will have no effect on the tone color.

Press the ENV INV (envelope invert) foot switch and try the above VCF experiments again, but this time with the VCF CUTOFF FREQ control between "7" and "8" instead of "3".

The ENV INV foot switch inverts the effect that picking a string has on the sound. Instead of sweeping up, then down, the sound will sweep down, then back up to the initial CUTOFF FREQ setting. For this reason, the VCF CUTOFF FREQ control will have to be set initially higher than with the normal ENV MOD mode.

From the above experiments, the basic idea of how the VCF works can be understood.

CAUTIONS WHEN PLAYING

When playing arpeggios and using envelope modulation of the VCF, the VCF cutoff point will simultaneously follow the vibrations of all the notes. If this effect is not desired, dampen the previously picked string.

COMPRESSION

Set the VCF so that sound passes through it without being processed or affected by it. To do this, set the VCF CUTOFF FREQ control at maximum, RESONANCE at "0", and the ENV MOD foot switch at OFF (LED above the ENV MOD switch is not lit). With the DUET switch ON, the sound from the VCO's and the fundamental pitches from the strings are combined and pass through the VCF without being affected. Try picking one of the strings and note that the VCO sound has a quick attack and dies away slowly, just like the original guitar sound.

Set the COMPRESSION switch at ON and try picking a string again. The effect is to prolong the sound. The COMPRESSION mode is most often used when synthesizing such sounds as brass and string sounds.

CAUTIONS WHEN PLAYING.

When there is no sound, the compressor circuit is at maximum gain and the Guitar Controller will be very sensitive to noises caused by handling.

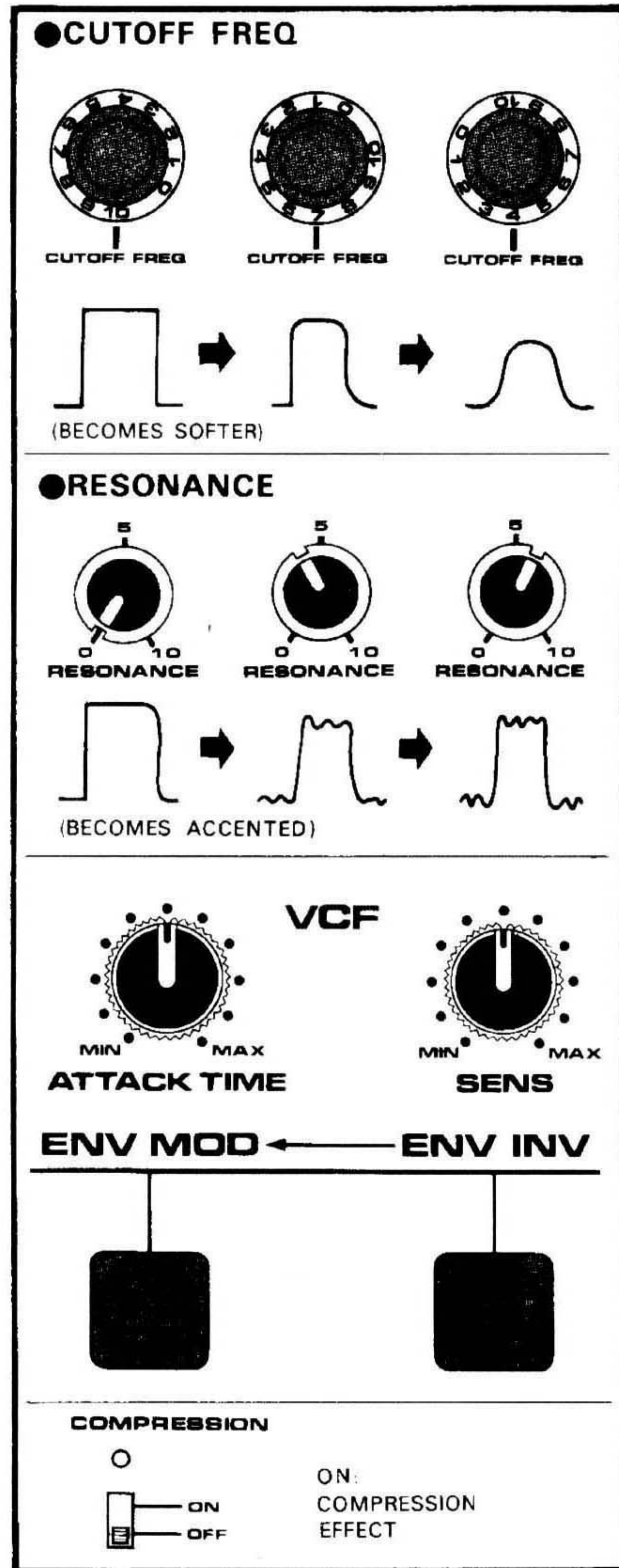

VCO VIBRATO

Next, let's try different ways of **modulating** or **controlling** the VCO's. First is vibrato, which is a slight wavering of pitch. Vibrato can be produced in the normal guitar way by using the finger to vary the tension on the string, or it can be produced electronically for a wide number of effects.

Set the VIB DEPTH (vibrato depth) knob on the Guitar Controller at "10". This may or may not produce the vibrato effect. If not, touch the metal upper end (Touch Plate 1) of the humbucking pickup near the bridge of the Guitar Controller to turn the vibrato effect ON. To turn it OFF, touch the opposite end (Touch Plate 2) of the pickup. The vibrato will decay after **releasing** the touch plate.

With the vibrato ON, try various positions of both the VIB DEPTH control on the Guitar Controller and the LFO RATE (LFO = low frequency oscillator) control on the Guitar Synthesizer and note the effects. VIB DEPTH controls the depth of the vibrato effect and the LFO RATE controls the speed of the vibrato.

The electronic vibrato affects only the VCO's. In the DUET mode, the combination of the non-vibrato fundamental string pitches with the vibrato VCO pitches produces the chorus effect sound.

The **Guitar Controller Instruction Manual** contains additional information on the vibrato ON/OFF function.

If a foot switch is used with the rear panel COMP jack, the ON/OFF function of the compression can be controlled with a foot switch.



TOUCH PLATE 2
Turns VIBRATO effect OFF, or for touch-Vibrato.

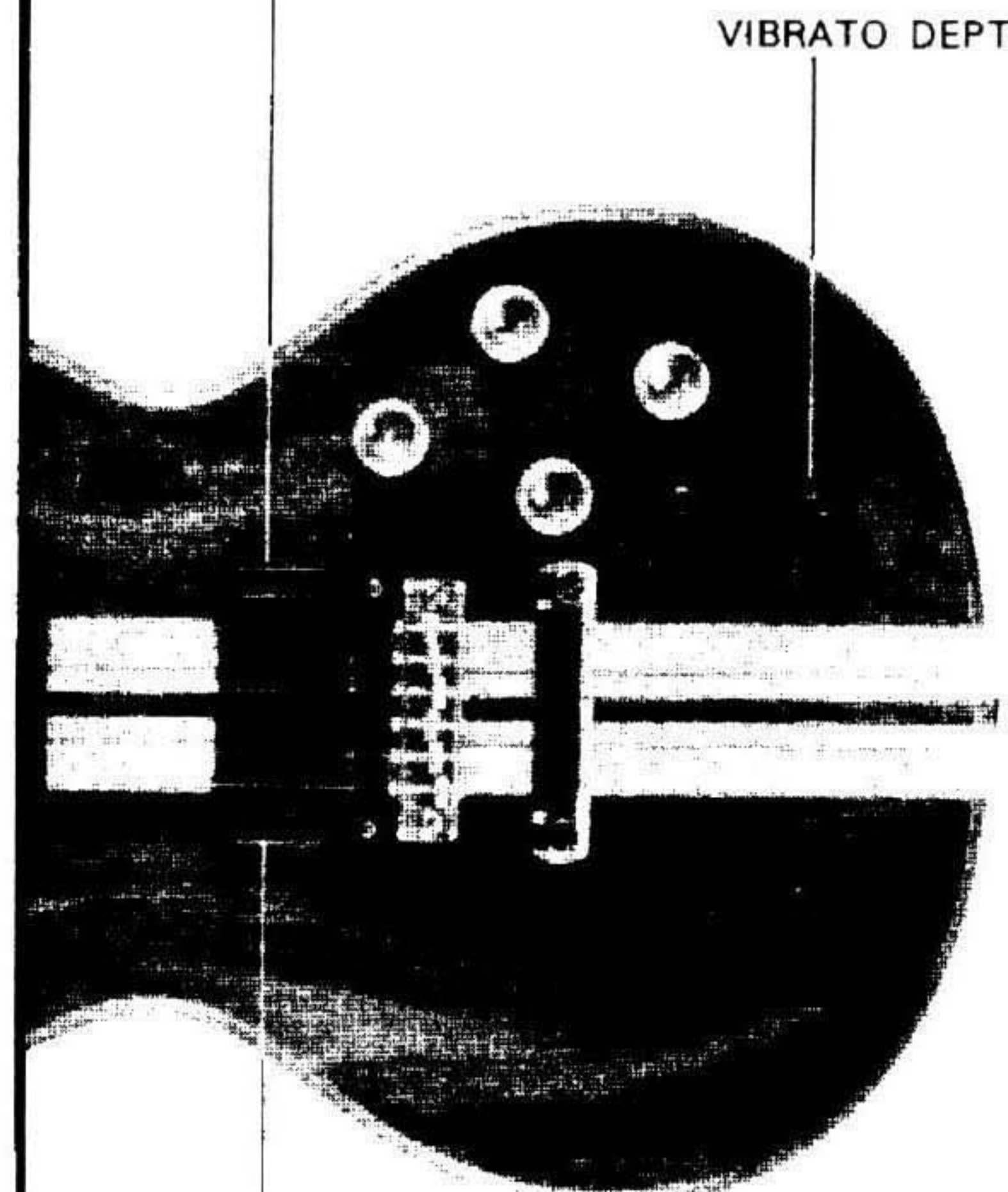

TOUCH PLATE 1
Turns the VIBRATO effect on

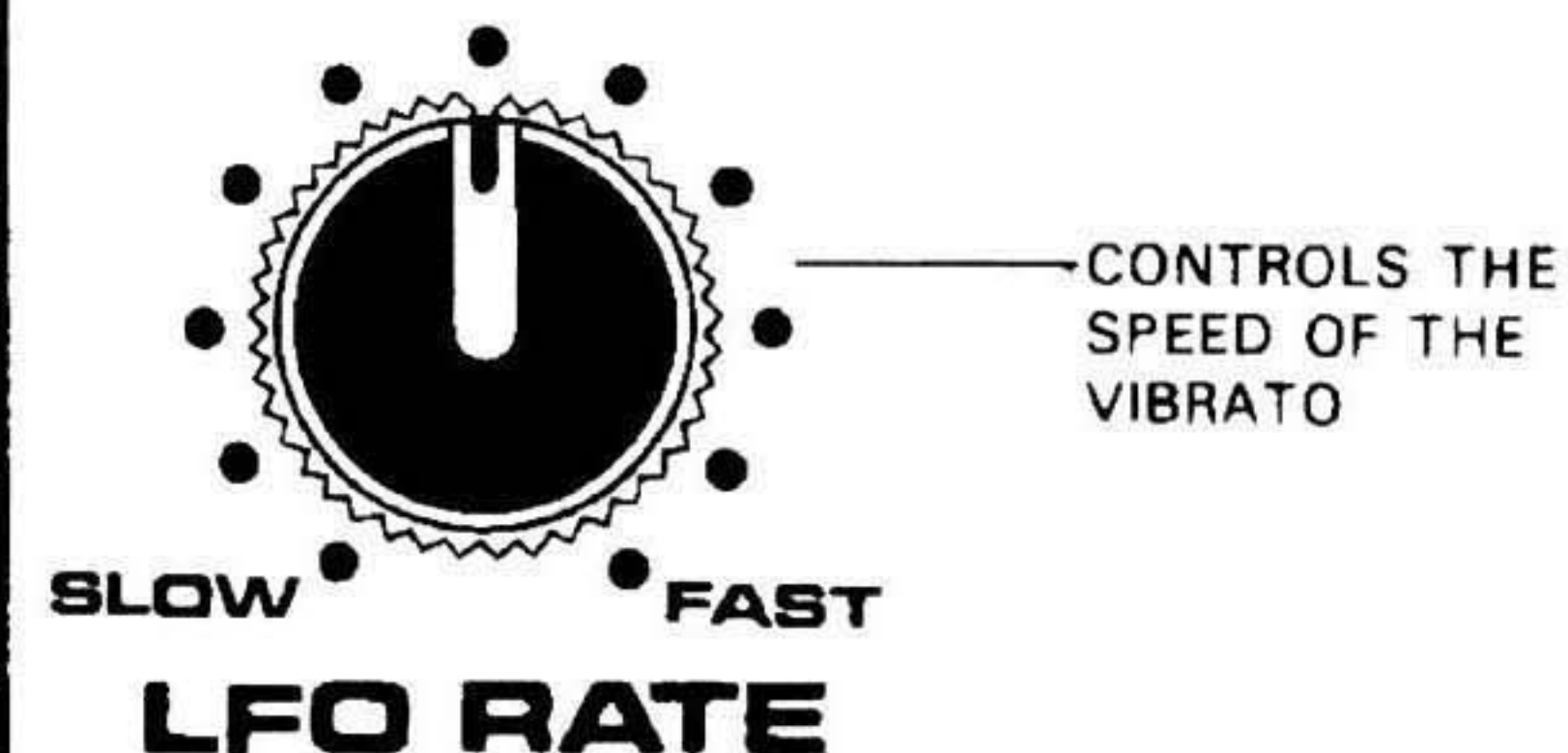

PITCH SHIFT

Another VCO effect is pitch shift, an effect where the VCO's can be shifted to pitches other than the string pitches. In the DUET mode, the fundamental pitches will be the same as the string pitches, and the VCO's can be turned to other pitches so that one instrument produces the effect of a very large group.

Set the Guitar Synthesizer and Controller for the standard settings shown on page 4, but with the BALANCE control fully clockwise. Press the DUET foot switch. Next, press the PITCH "A" foot switch and note that the LED above the switch lights. While producing sound, try turning the PITCH "A" knob up and down and note that this now controls the VCO pitches. Try tuning the VCO's to a perfect fourth below the fundamental string pitch. For this, the PITCH "A" knob will be set somewhere near -3

Next, try Pitch "B" by pressing the PITCH "B" foot switch and adjusting the PITCH "B" knob so as to produce the interval of a major third above the fundamental.

At this point, "A" tuning is a perfect fourth below the fundamental string pitch and "B" tuning is a major third above. The VCO tuning can now be switched instantly and accurately between these two preset pitches and unison by pressing the appropriate PITCH foot switch. Pressing PITCH "A" produces the "A" tuning; pressing it again cancels the "A" tuning. Pressing PITCH "B" produces the "B" tuning, and pressing again cancels it. It is possible to switch from "A" to "B" or from "B" to "A" without passing through unison by merely pressing the new pitch foot switch.

The UNLATCH/LATCH switch below each PITCH knob controls the latching function of the related PITCH foot switch. At LATCH, the pitch change function will alternate between the ON and OFF state each time the foot switch is pressed as described in the preceding paragraph. At UNLATCH, the tuning function will be ON only while the foot switch is held down and OFF when it is released.

It is possible to add a pitch sweep (portamento) to the pitch shift effect. Set the controls as they were previously ("A" pitch a perfect fourth below the fundamental and "B" pitch a major third above), then set both RISE TIME and FALL TIME at "5". While producing sound, press the PITCH "A" foot switch and note that the pitch slides downwards from unison to the "A" tuning. Next press the PITCH "B" foot switch and the pitch will slide from the "A" tuning to the "B" tuning.

RISE TIME controls the amount of time required for the pitch to change when it rises; FALL TIME controls the amount of time required when the pitch falls. Note that this effect occurs only when using the pitch shift effect and is not the same as the portamento effect which can be added to melodies played on a keyboard type synthesizer. When "instant" changes are desired, the controls should be left at "0". Try this effect with RISE TIME AT "0" and FALL TIME at "10".

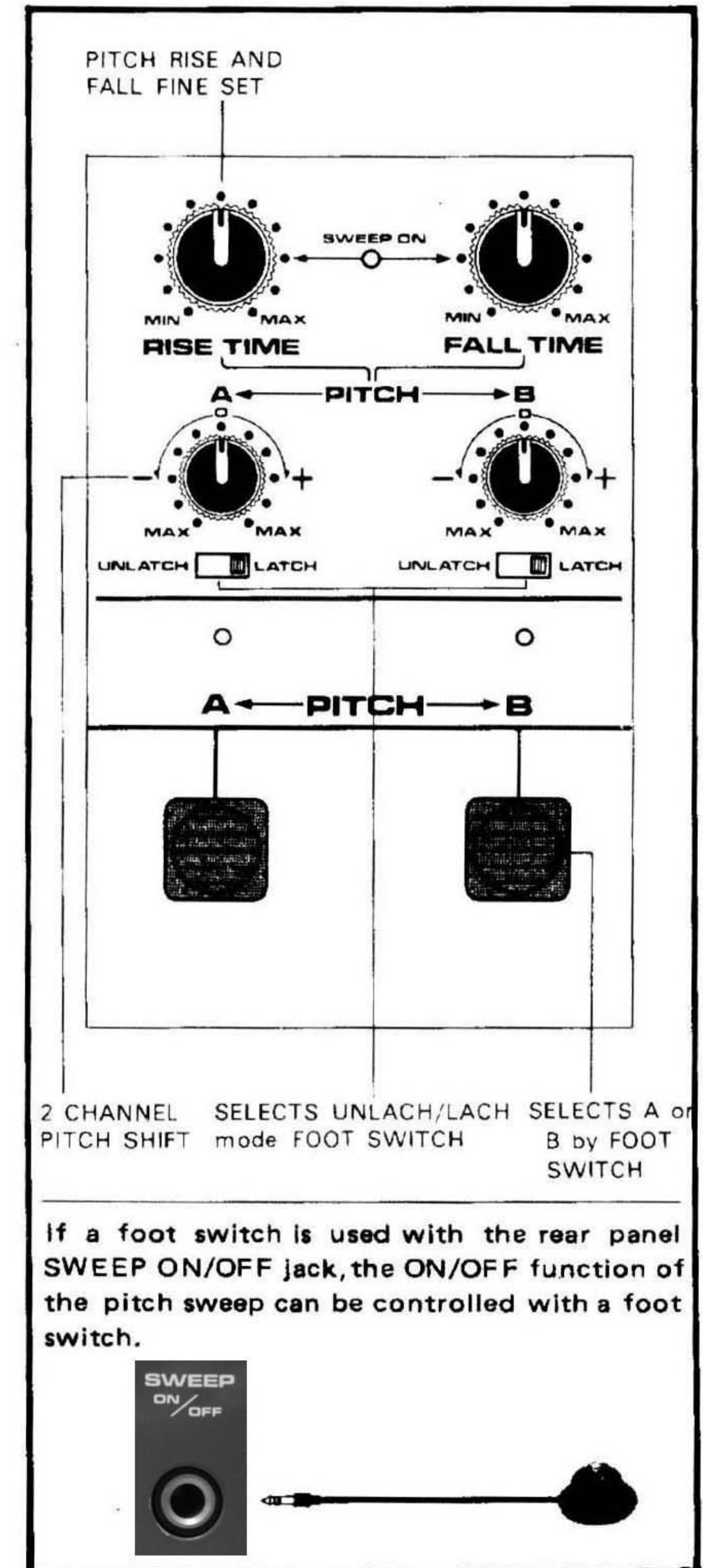

STRING SELECTOR

When using the guitar and synthesizer sounds simultaneously (Guitar Controller BALANCE control somewhere near center), the STRING SELECT switches can be used to determine which strings are to produce the synthesizer sounds. There are six switches, one for each string. Only those switches that are ON will produce synthesizer sounds. These switches can be used where it is desired to play a melody or a bass line against guitar chords, for example, or for other effects where the synthesizer notes are to be relatively independent of the guitar notes.

DISTORTION

There is one more switch on the Guitar Controller left to be explained. With this switch at the VCO position (pointing towards the bridge), the VCO synthesizer sound is produced. When changed to point in the opposite direction, the HEXA-DISTORTION effect is produced. At center, both synthesizer and distortion sounds are produced.

The GR-300 distortion is different from ordinary guitar distortion in that there is a separate distortion circuit for each of the six guitar strings thus producing an unusually clear distortion effect even when chords are played. This sound is also passed through the VCF where the tone color can be further processed. Try the VCO DISTORTION sound.

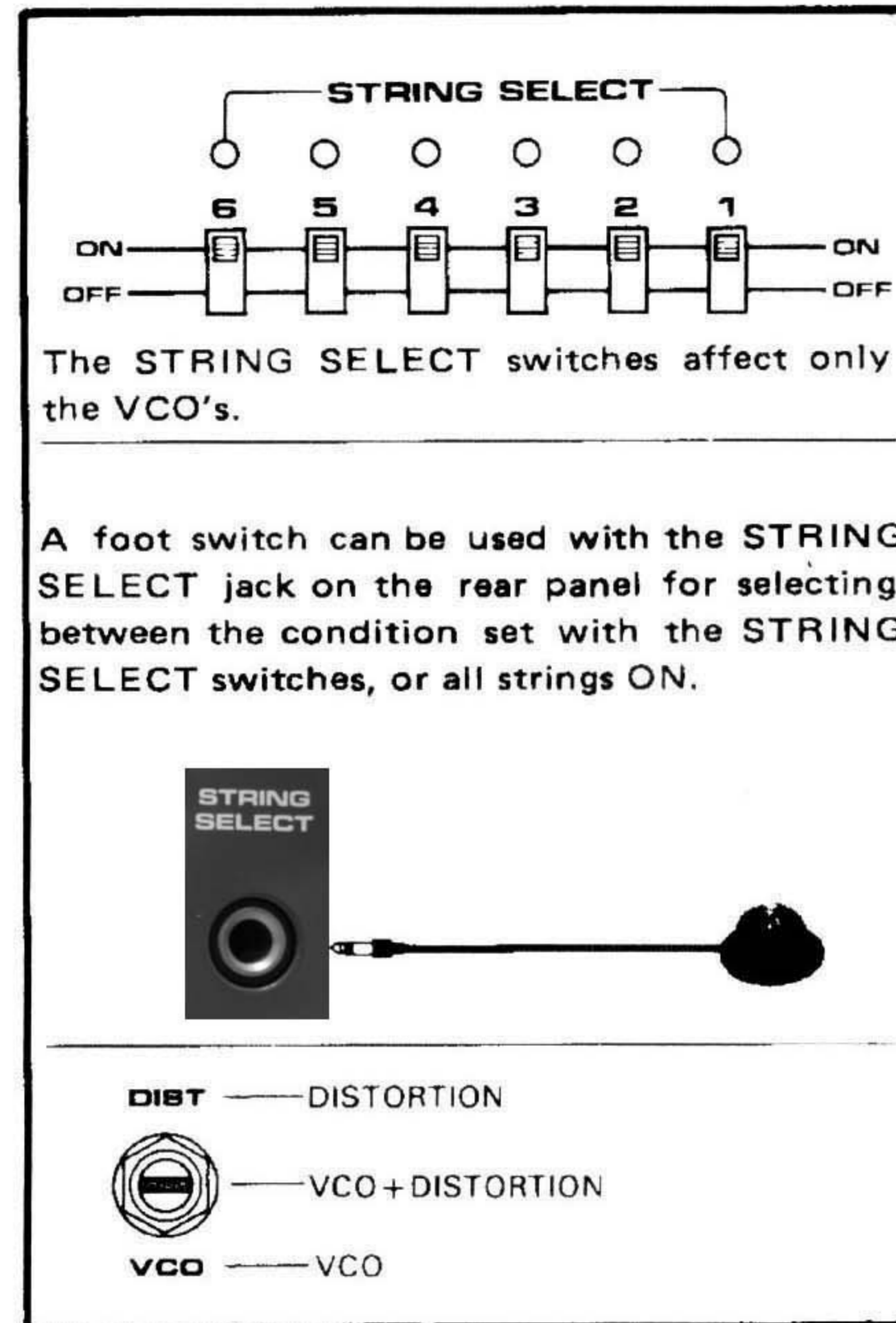





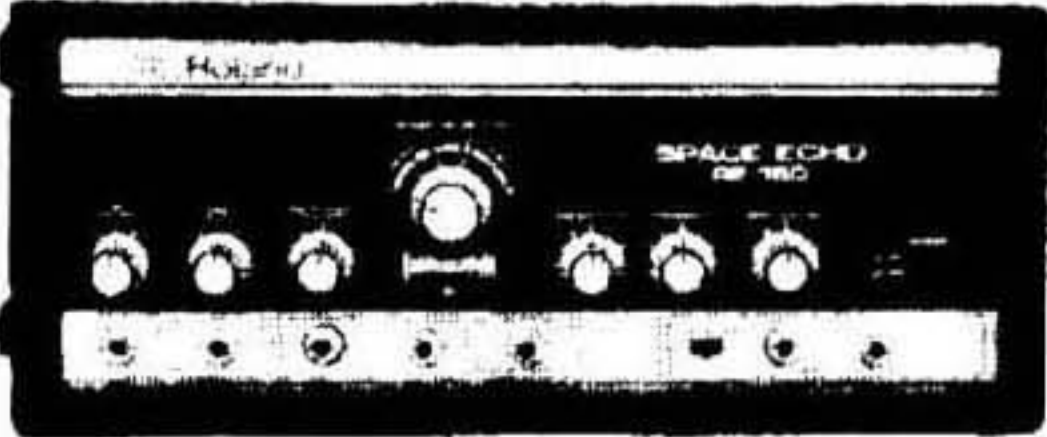
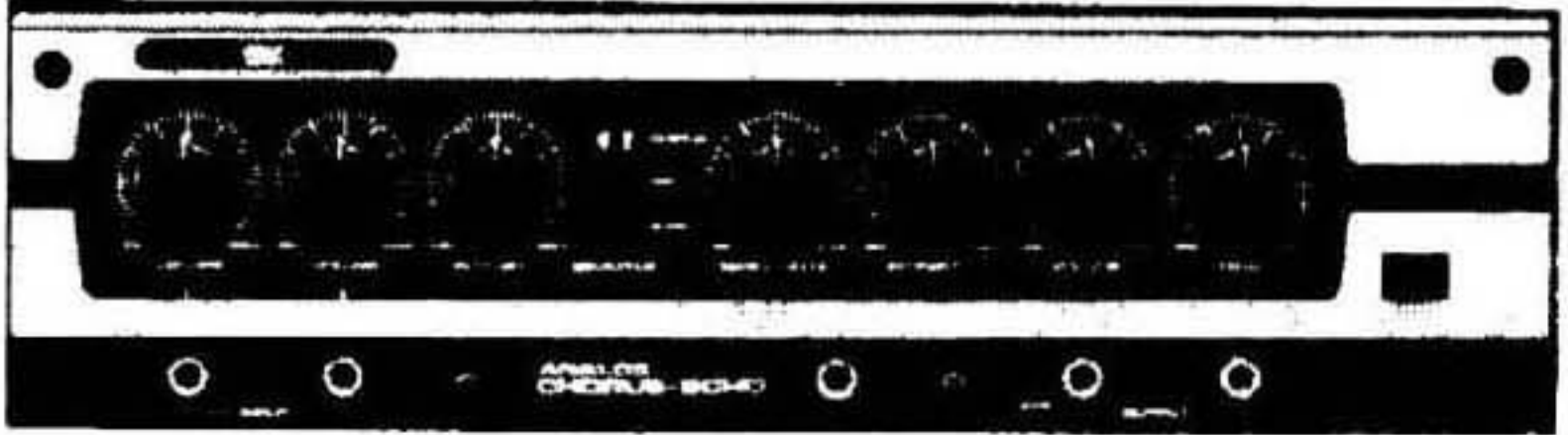

USING ATTACHMENTS

Attachments can be connected between the Guitar Synthesizer and the external amplifier. Since the GR-300 is a synthesizer, try devices designed for use with synthesizers, such as phase shifters, flangers, chorus and echo machines.

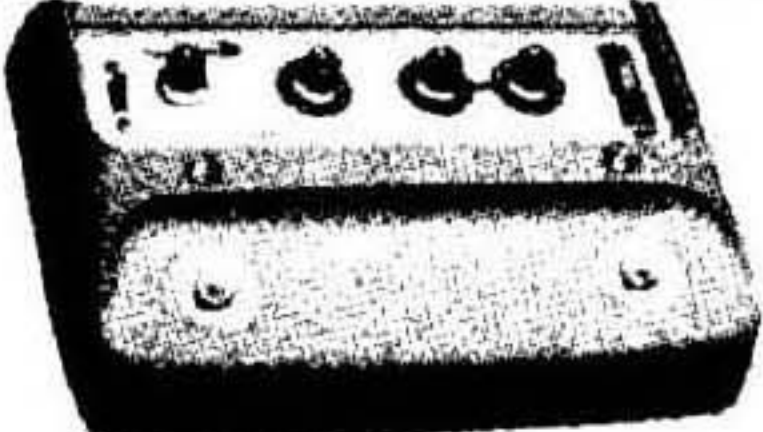
■ GR-300 + SPV-355

When a solo type synthesizer sound is desired, try the Roland P/V Synthesizer SPV-355. Use the NORMAL OUTPUT on the Guitar controller, or use the GUITAR OUTPUT from the GR-300.

ECHO CHAMBER		RE-501 RE-301 RE-201 RE-150
ANALOG ECHO		DC-30 DC-20
PHASER		SPH-323 PH-1
FLANGER		BF-1 BF-2 SBF-325
CHORUS		CE-1 CE-2
EQUALIZER		GE-10 GE-6
REVERB		RV-100
P/V SYNTH		SPV-355

SAMPLE SOUNDS

Following are a very few of the infinite range of possibilities with the Guitar Synthesizer. Try altering the sounds shown by changing controls slightly and using pitch shift, vibrato, duet mode, etc.

1 BASS

Turning on the ENV MOD (and the ENV INV) for a percussive bass sound.

▼ G-303/808

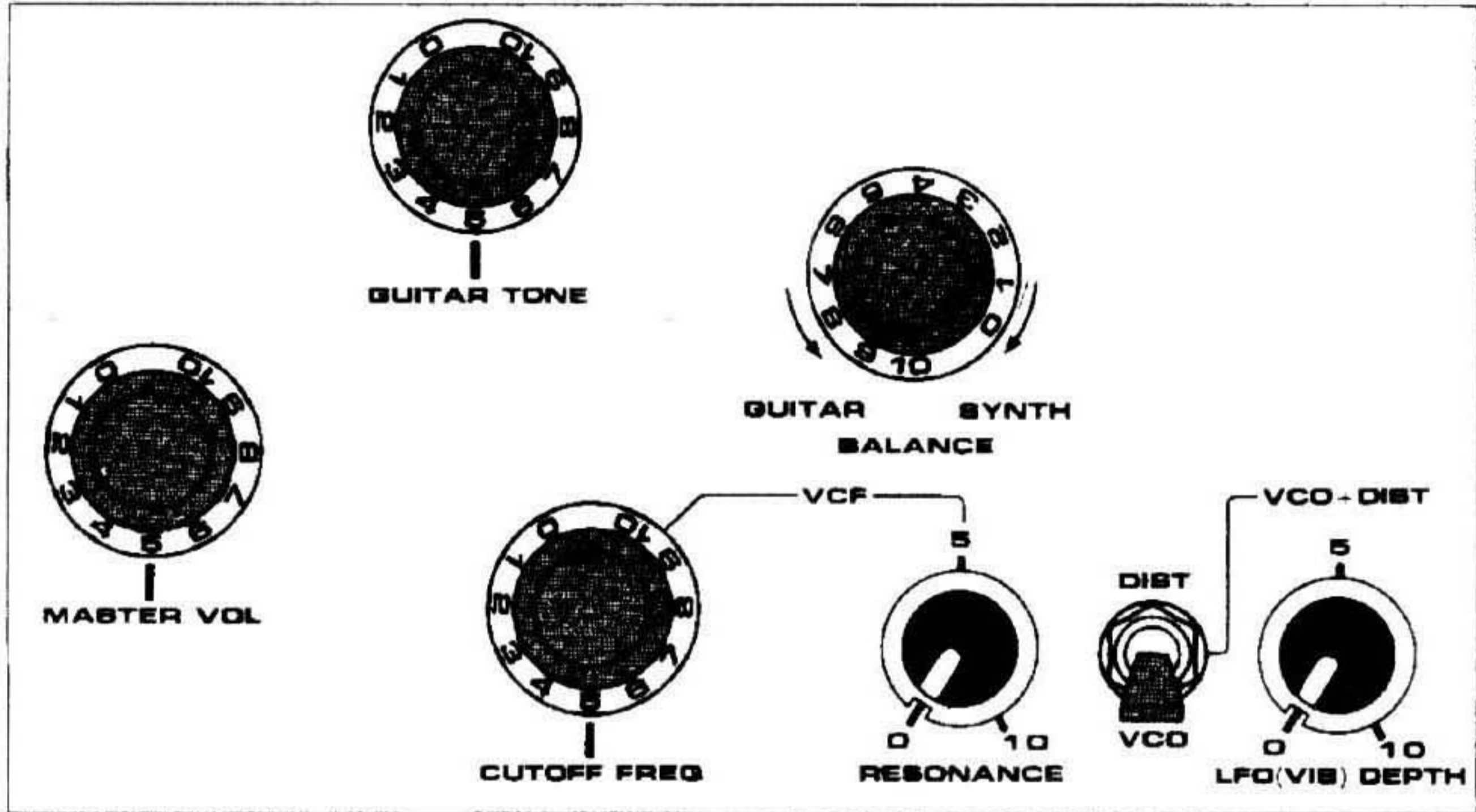

2 SYNTH BASS

Adjust the SENS and RESONANCE.

▼ G-303/808

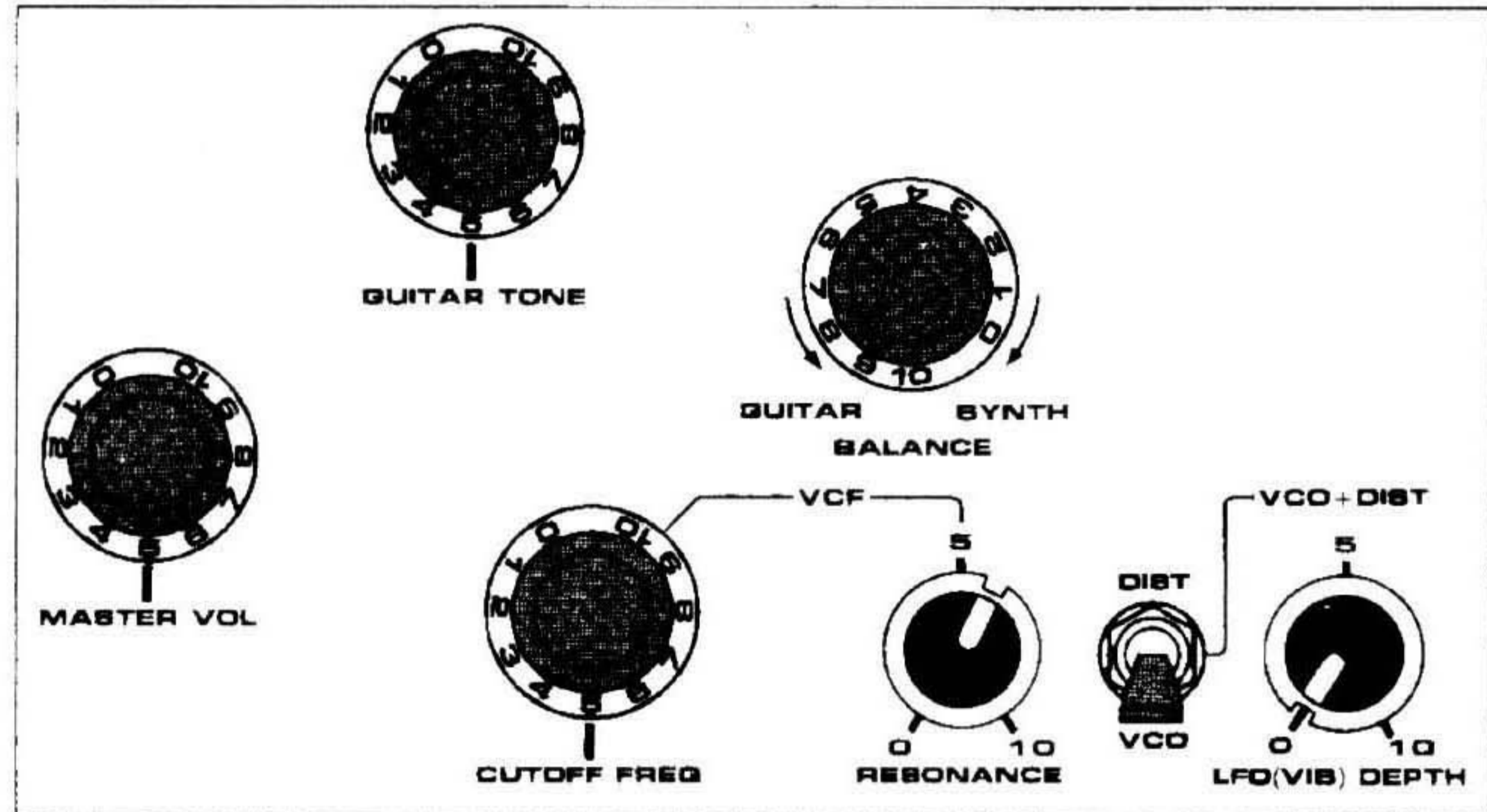

▼ GR-300

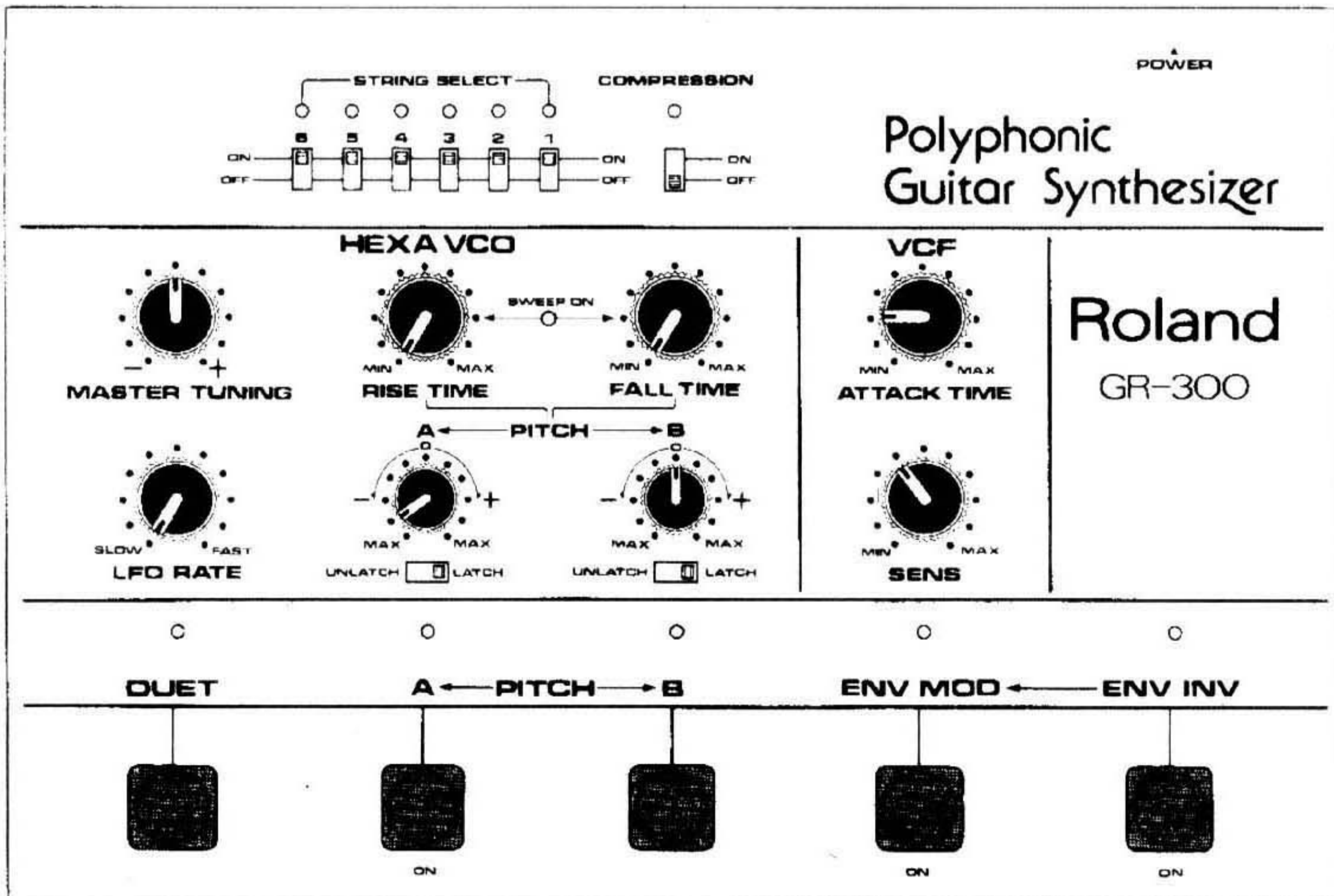

▼ GR-300

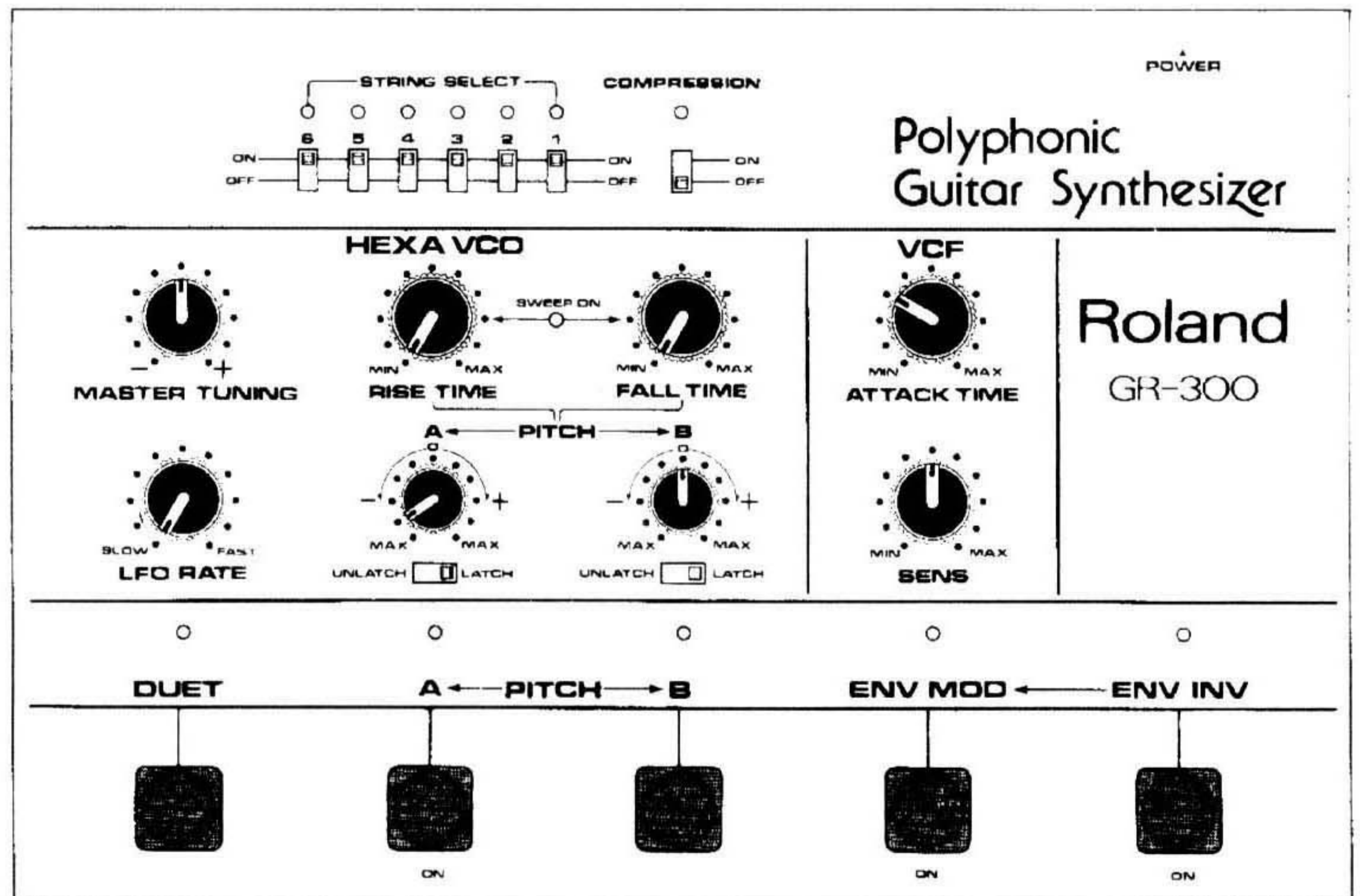

3 TUBA

Set the CUTOFF FREQ to the level between 2-6 depending on what is desired as an effect.

▼ G-303/808

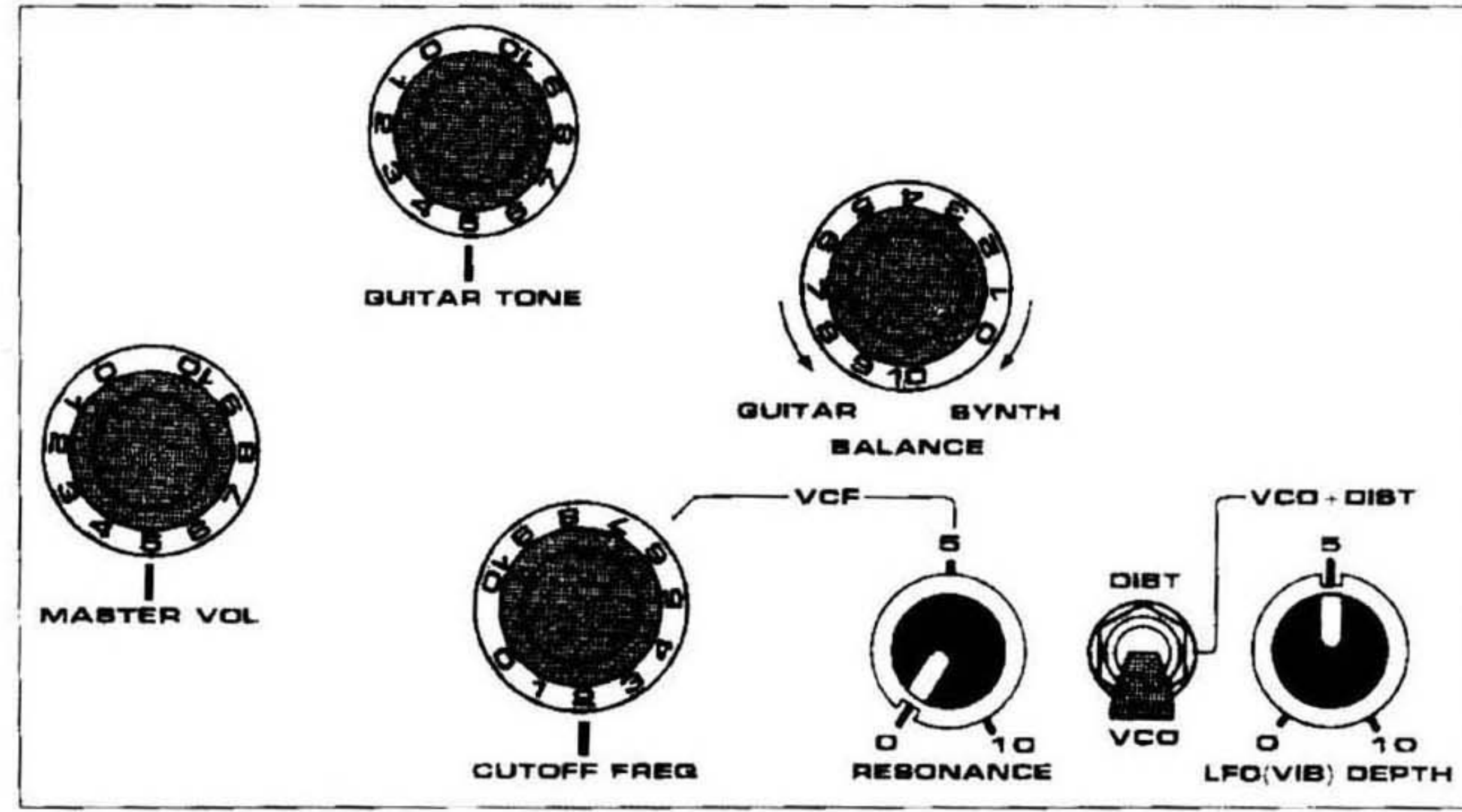

4 TROMBONE

It is also effective to turn on the DUET Switch.

▼ G-303/808

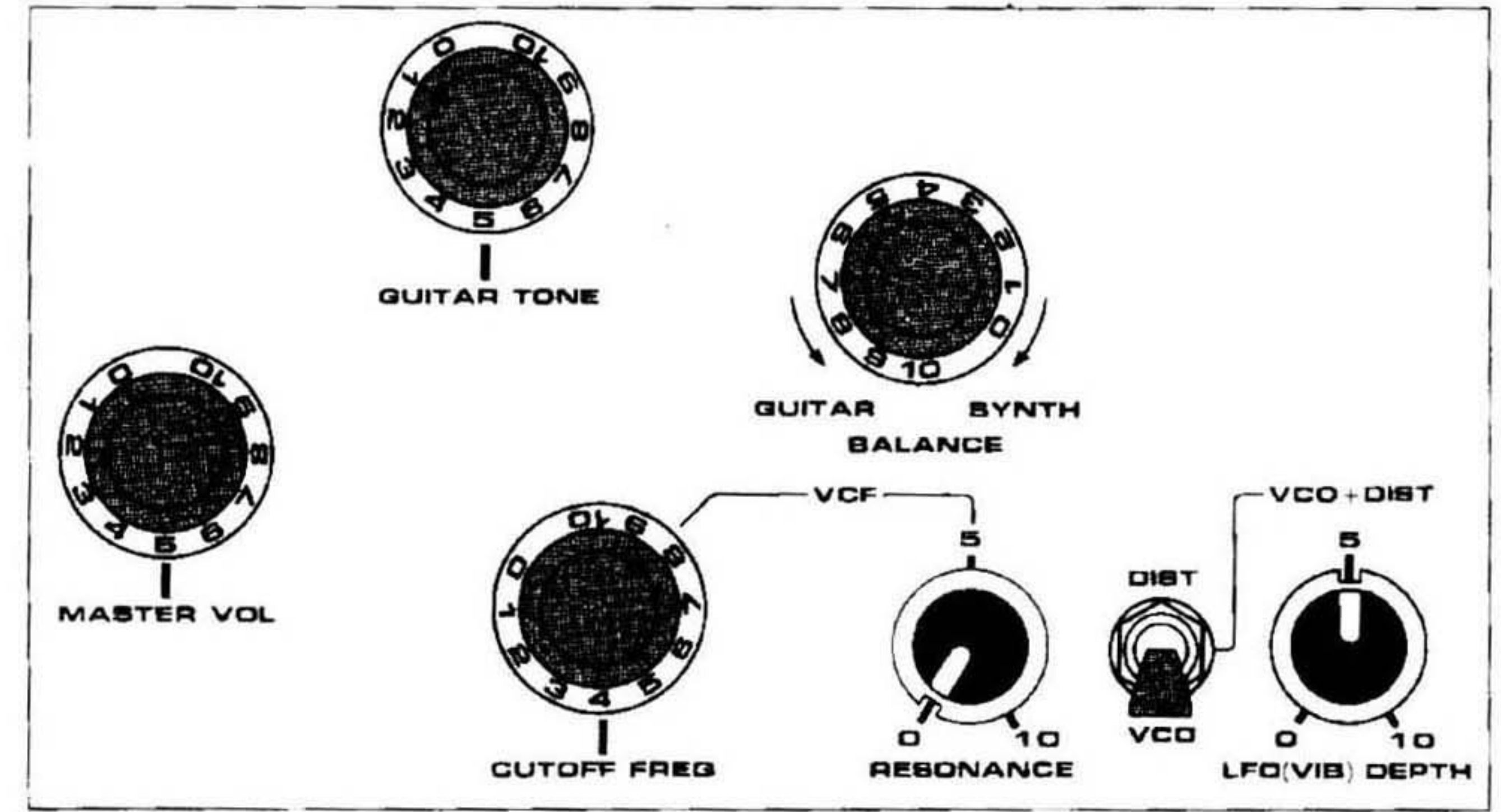

▼ GR-300

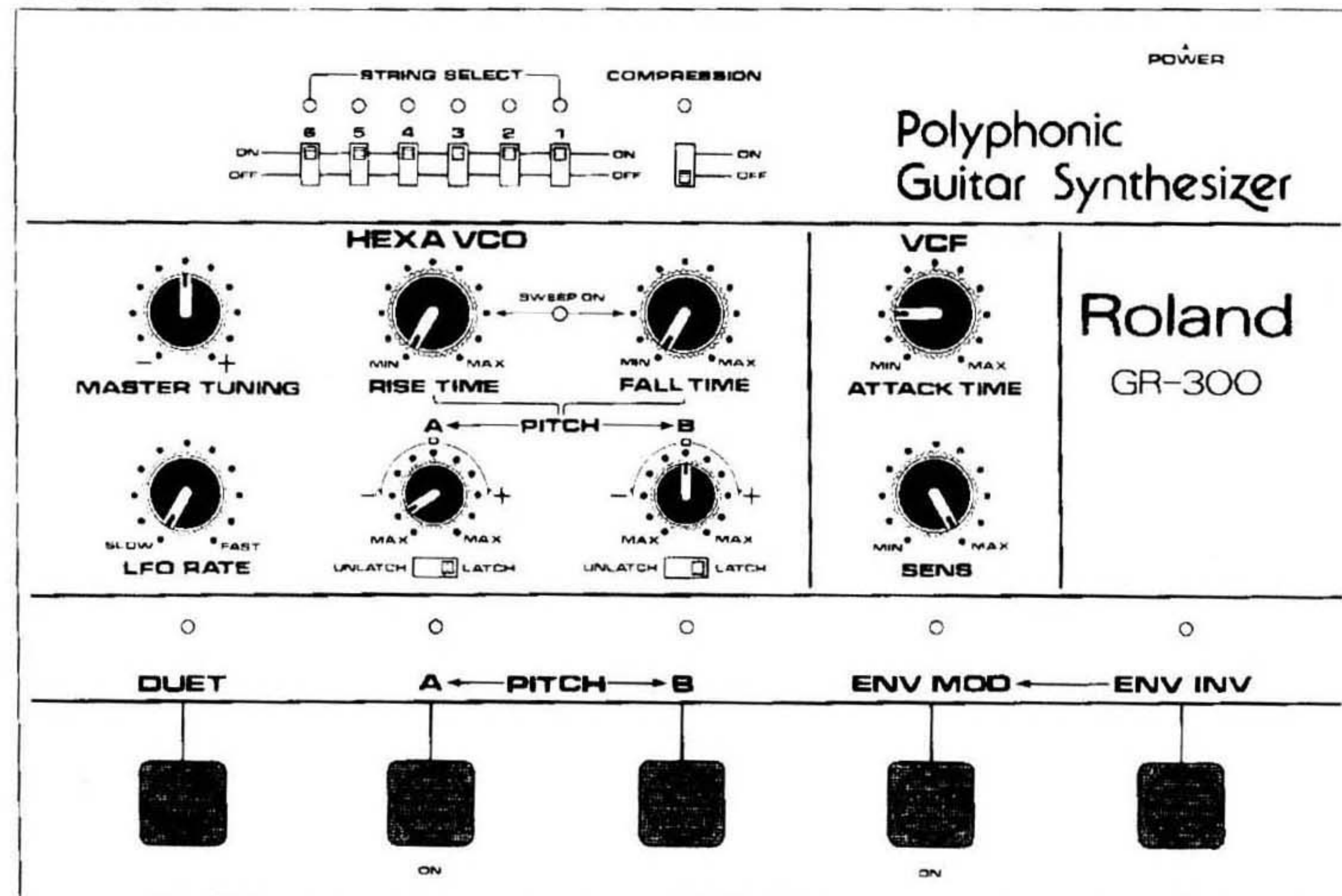

▼ GR-300

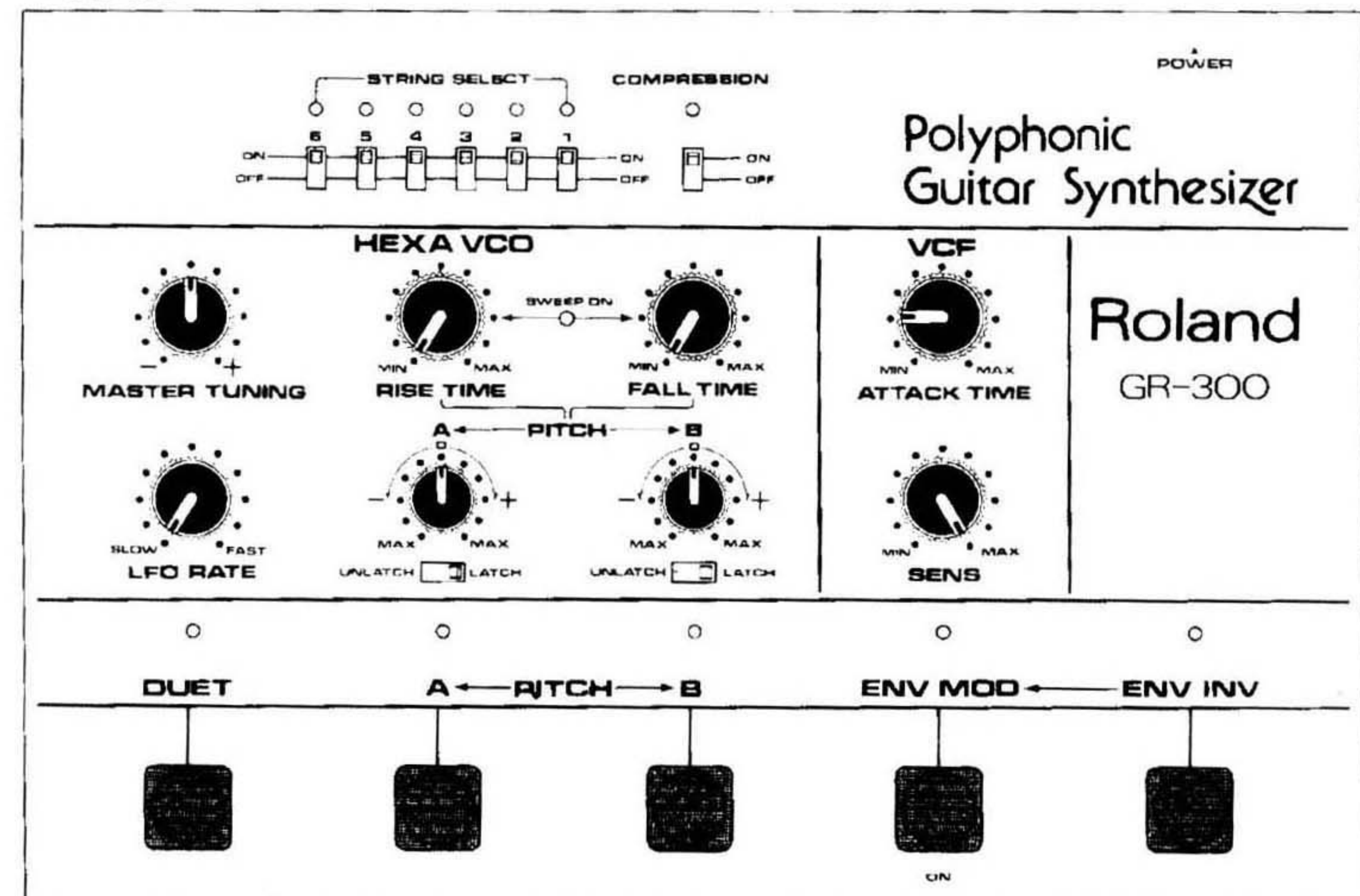

5 BRASS ENSEMBLE

It is important that the setting of the CUT OFF FREQ and the ATTACK TIME is done correctly.
It is also effective to turn on the DUET Switch.

▼ G-303/808

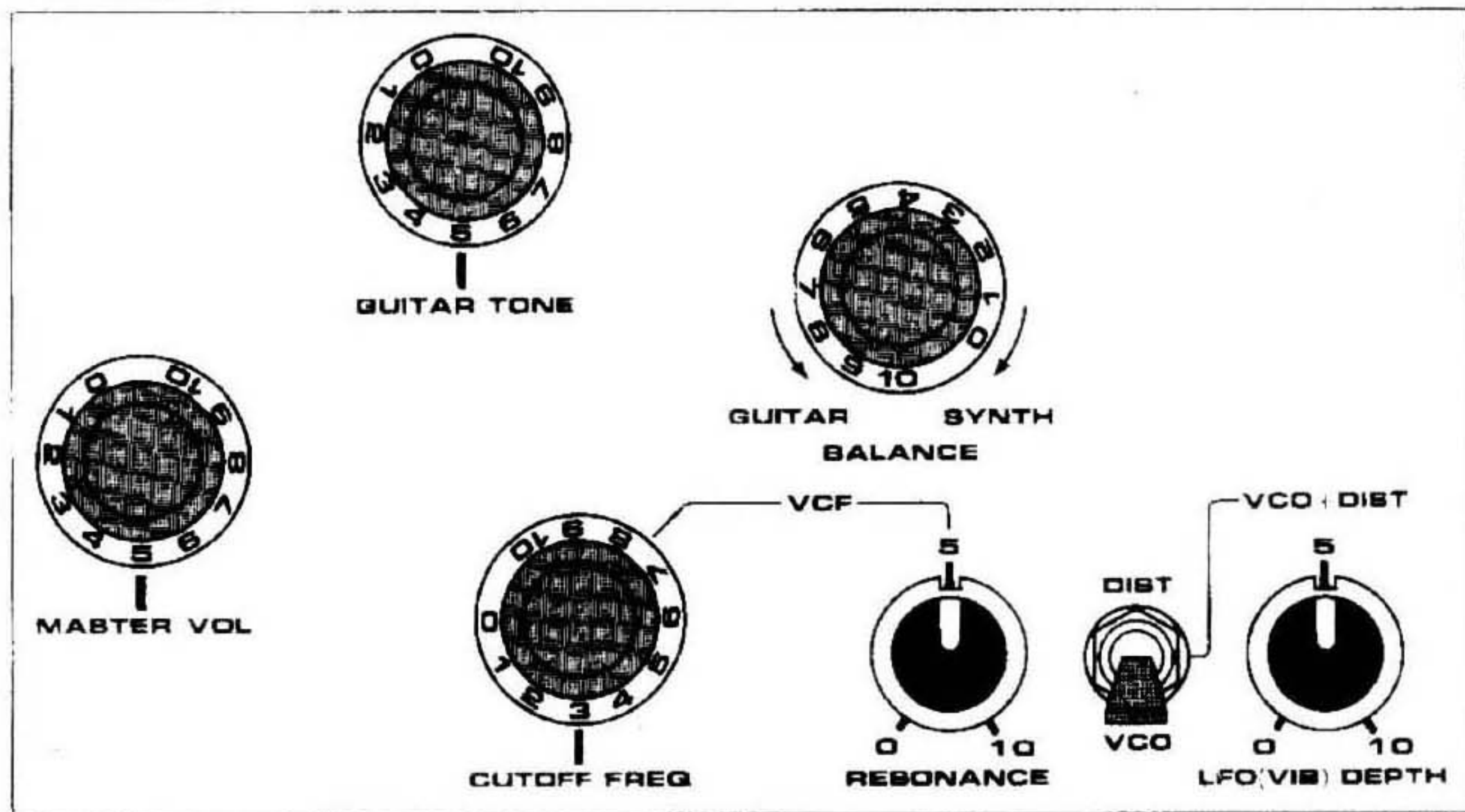

6 SYNTH VOICE

Use the pitch shifter effectively — Pitch A is the low-pitched voice, pitch B is the high-pitched voice.
Use the delay vibrato.

▼ G-303/808

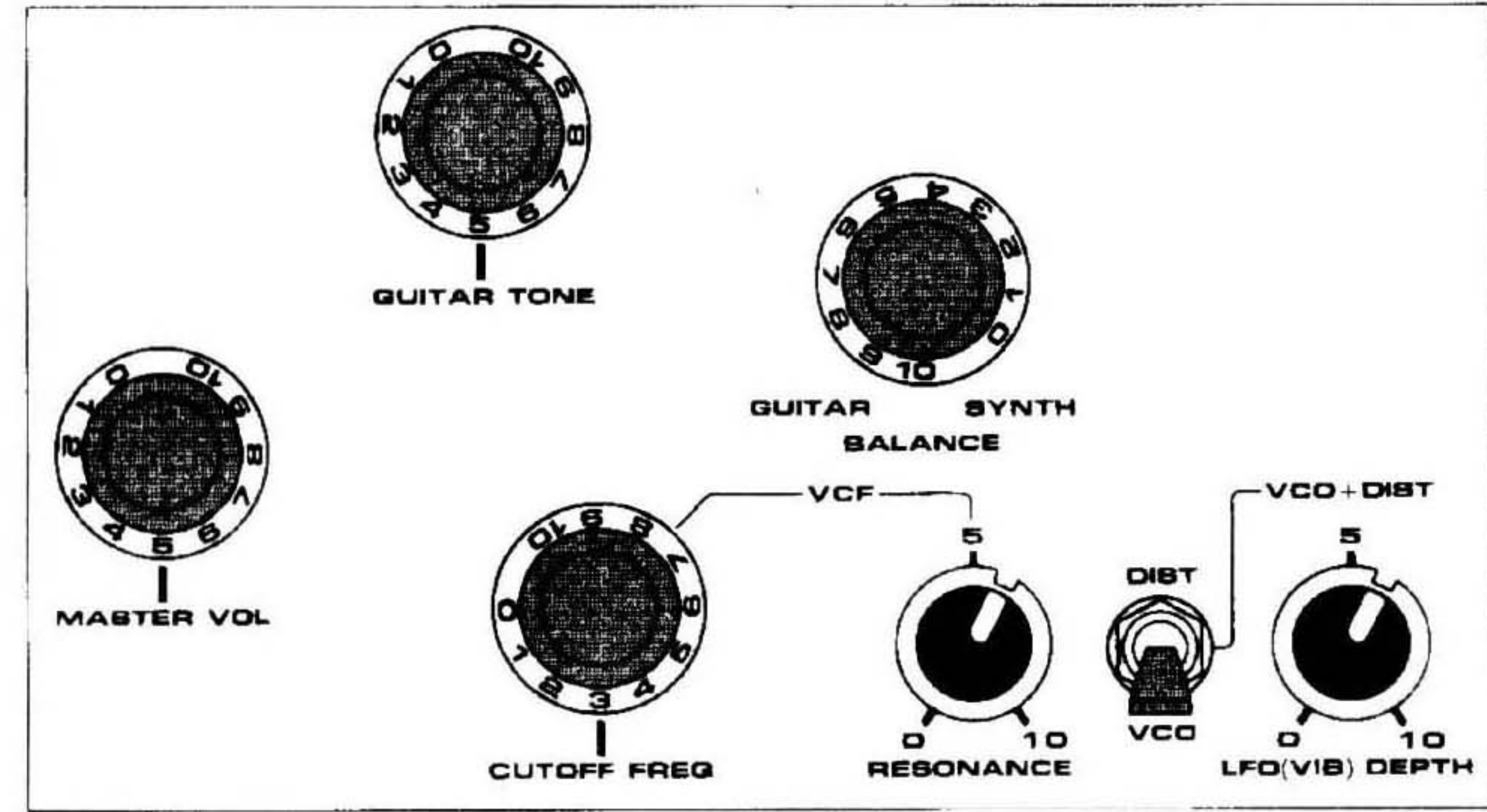

▼ GR-300

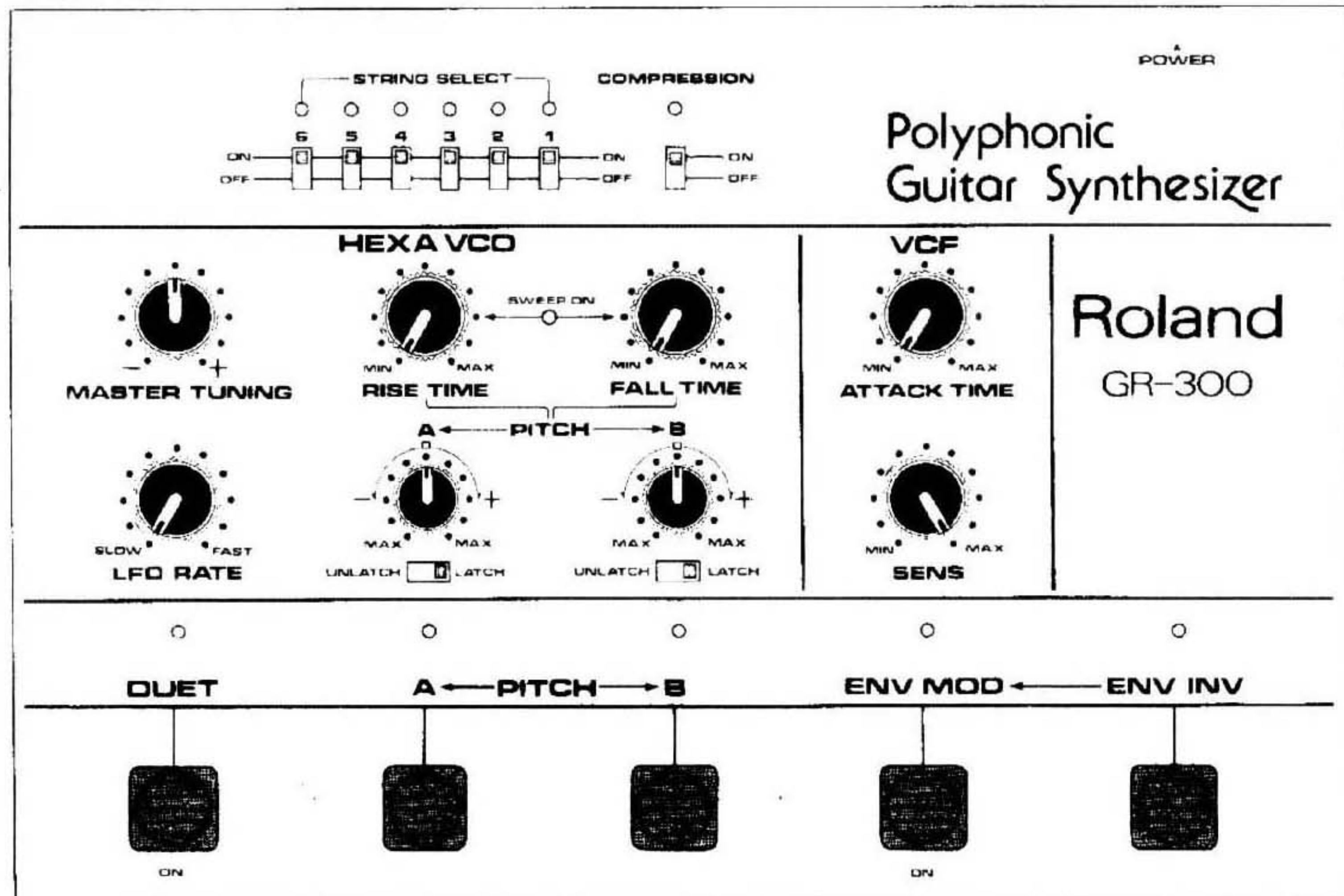

▼ GR-300

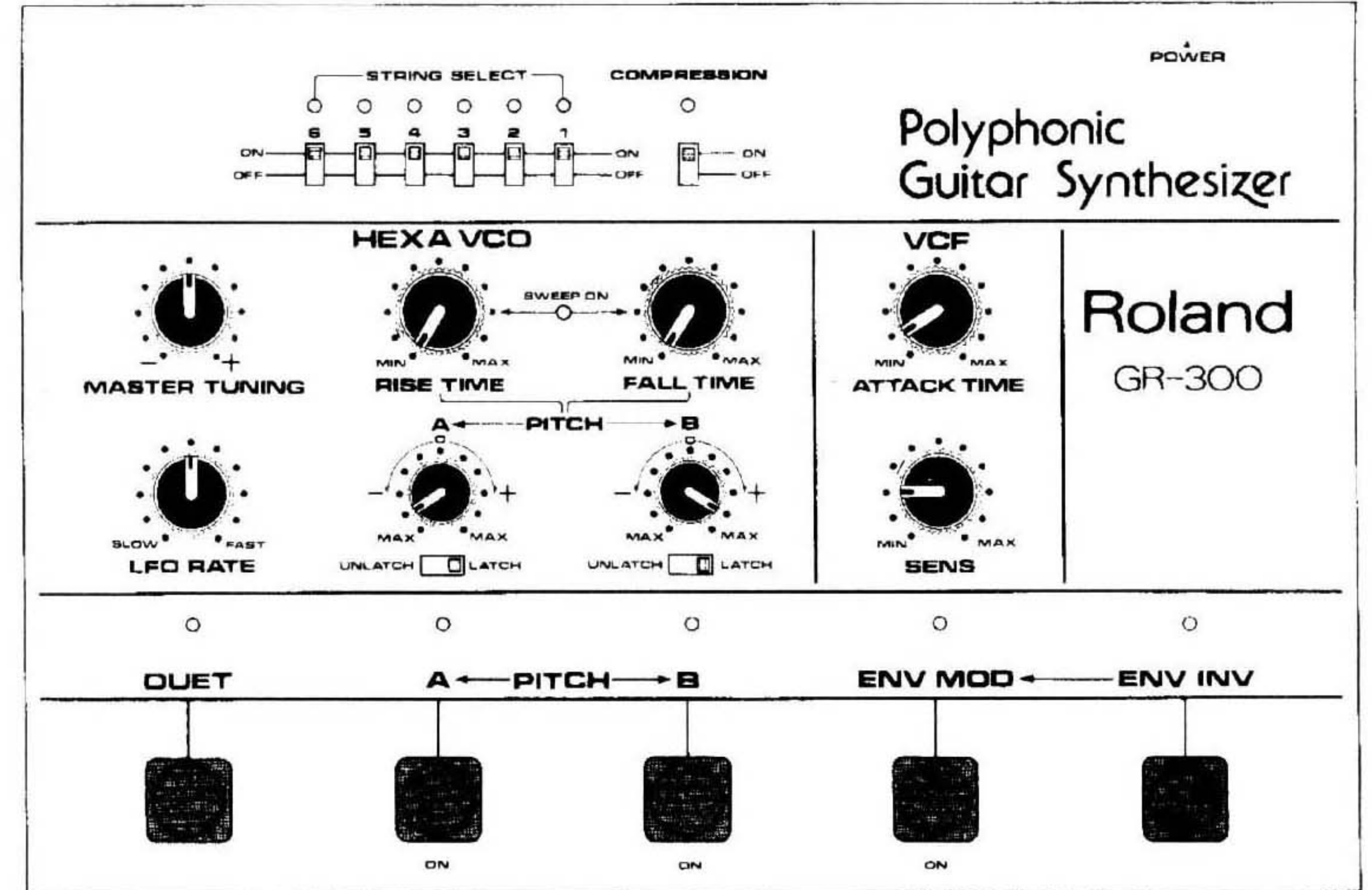

SAMPLE NOTES

▼G-303/808

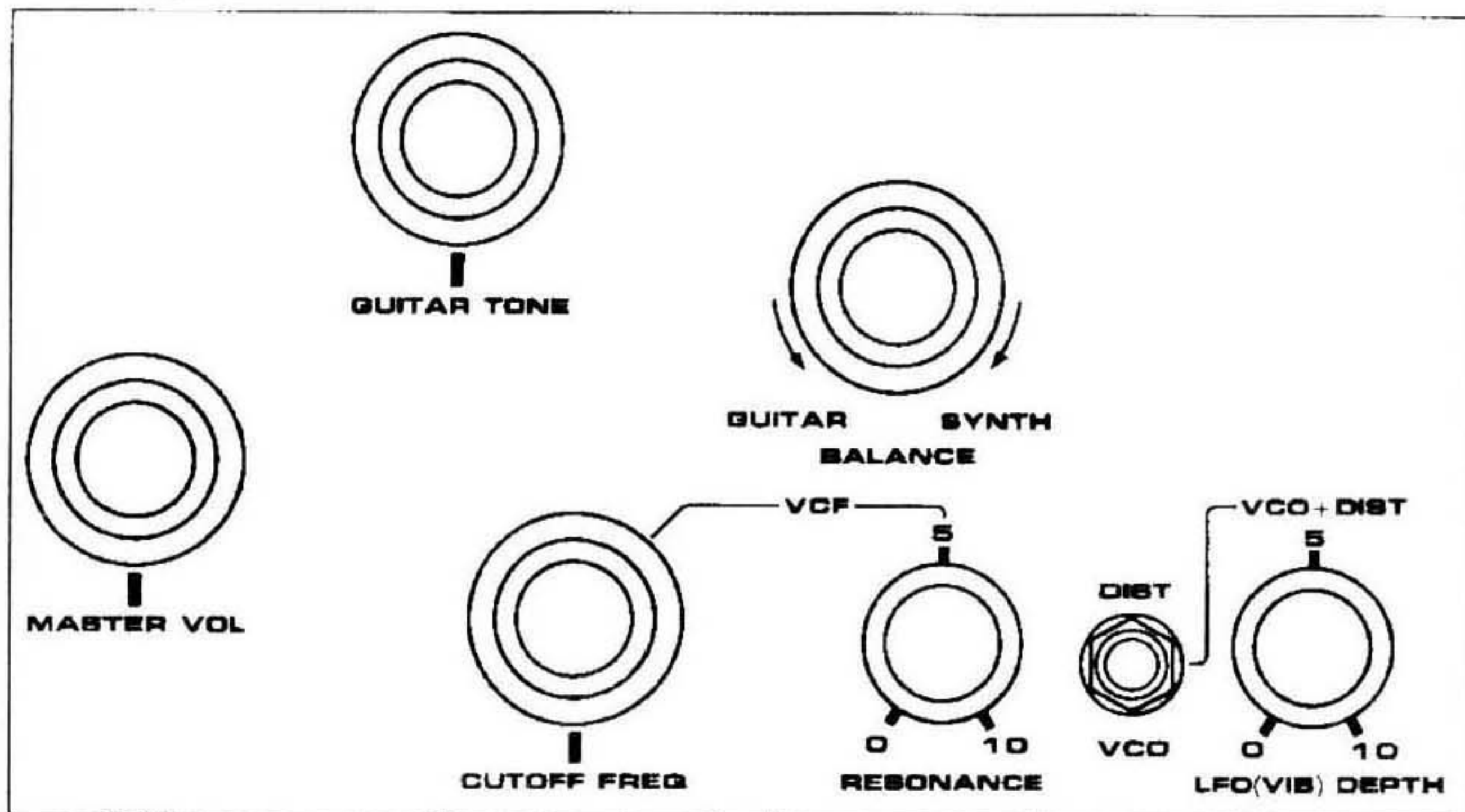

▼G-303/808

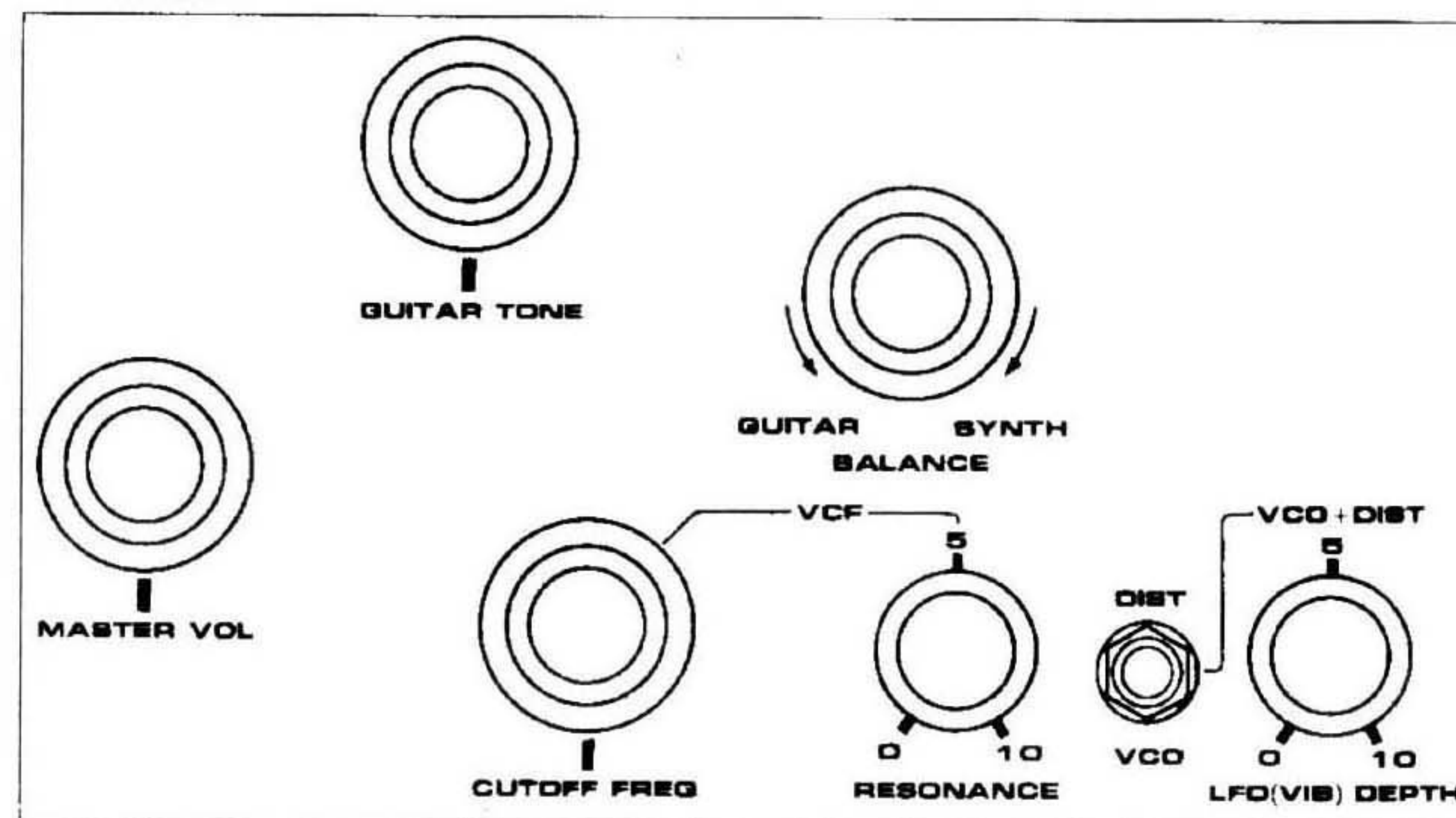

▼GR-300

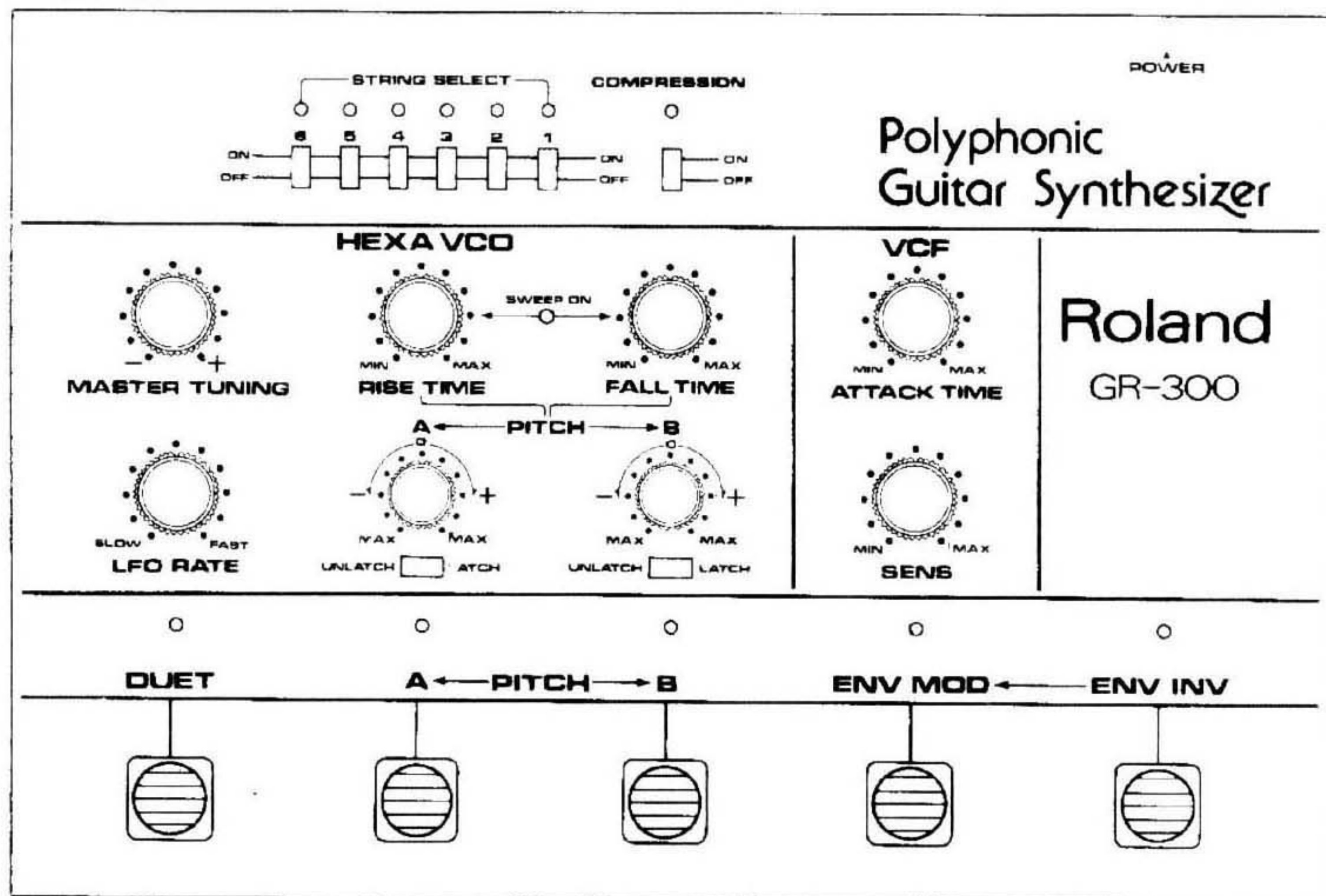

▼GR-300

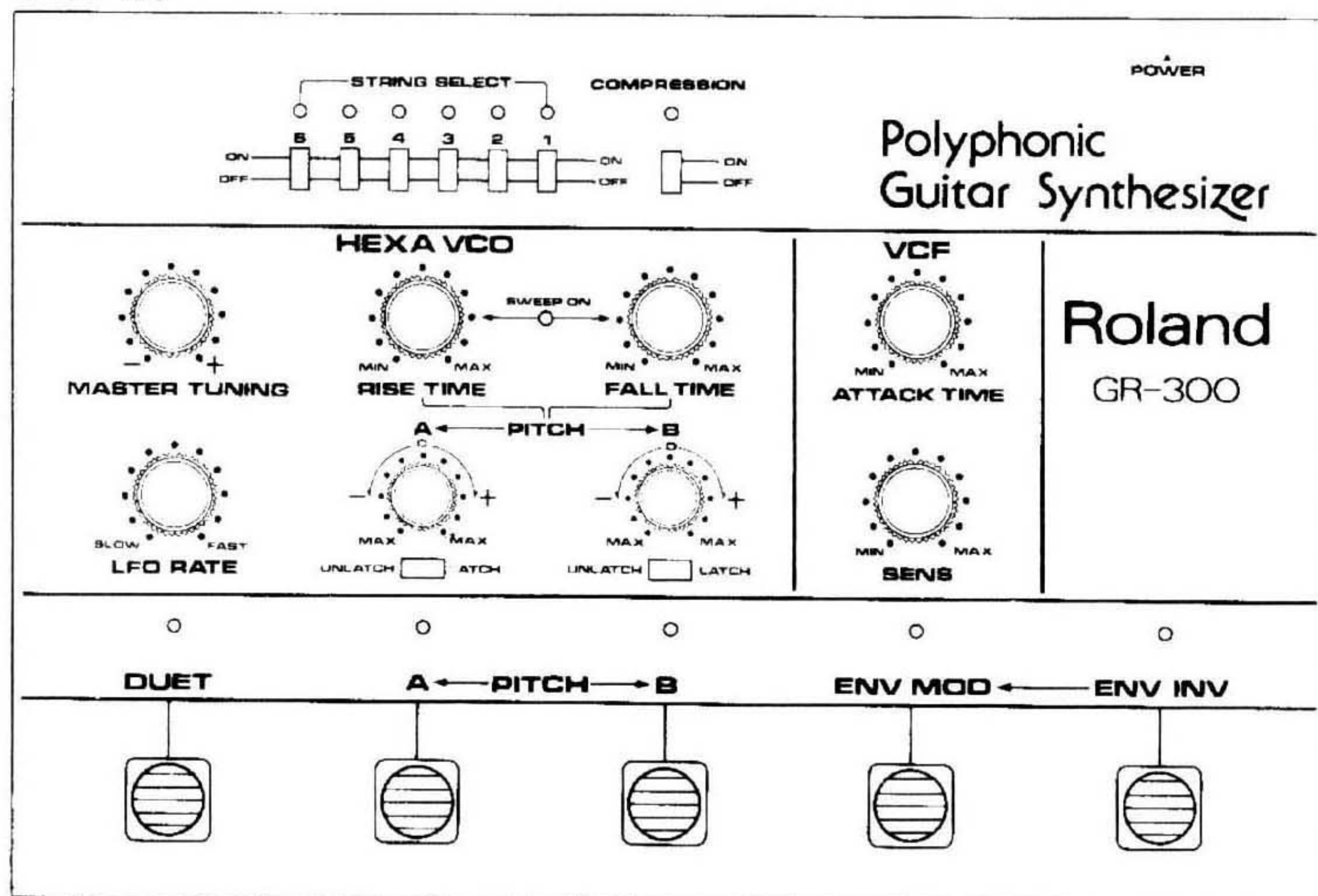

▼G-303/808

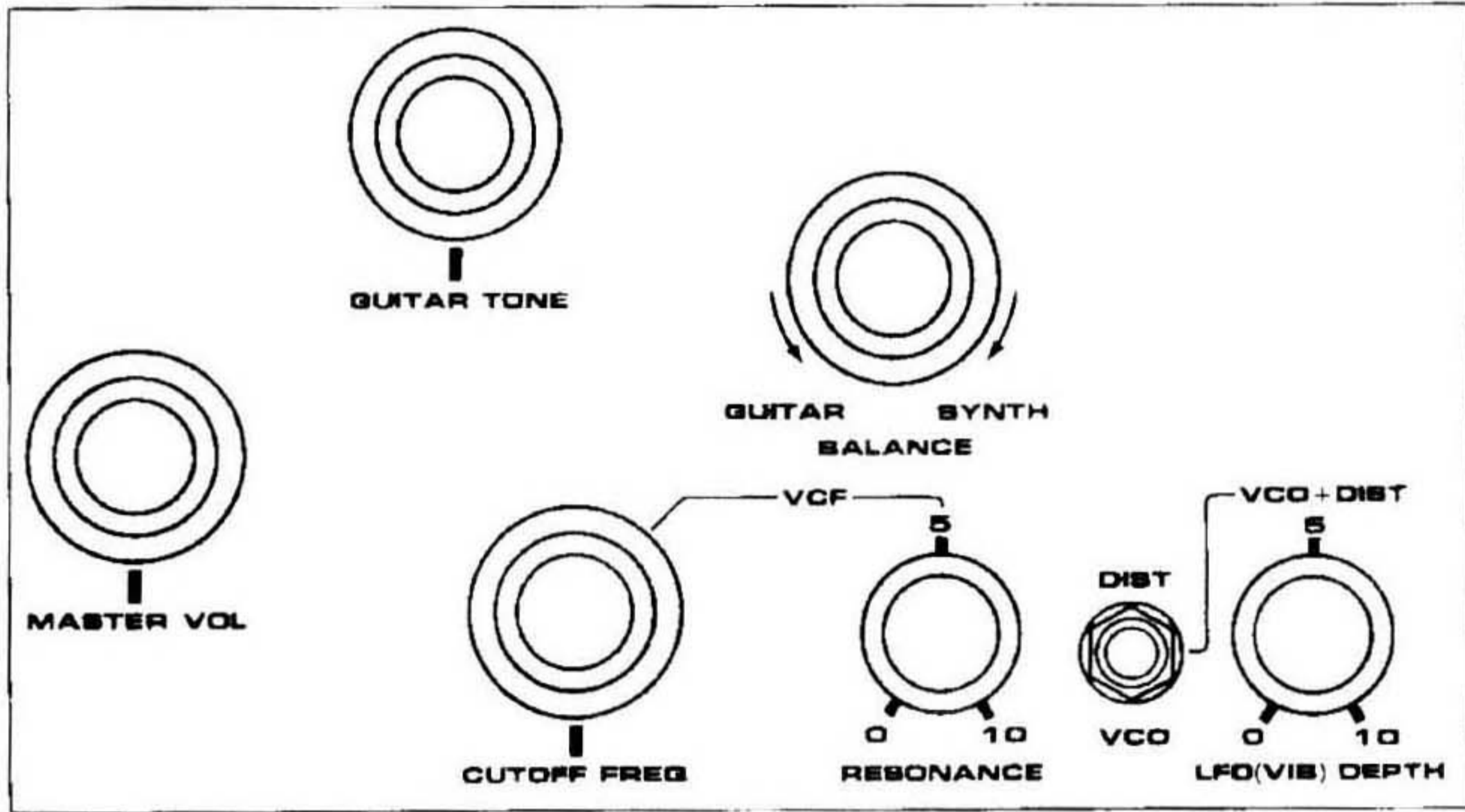

▼G-303/808

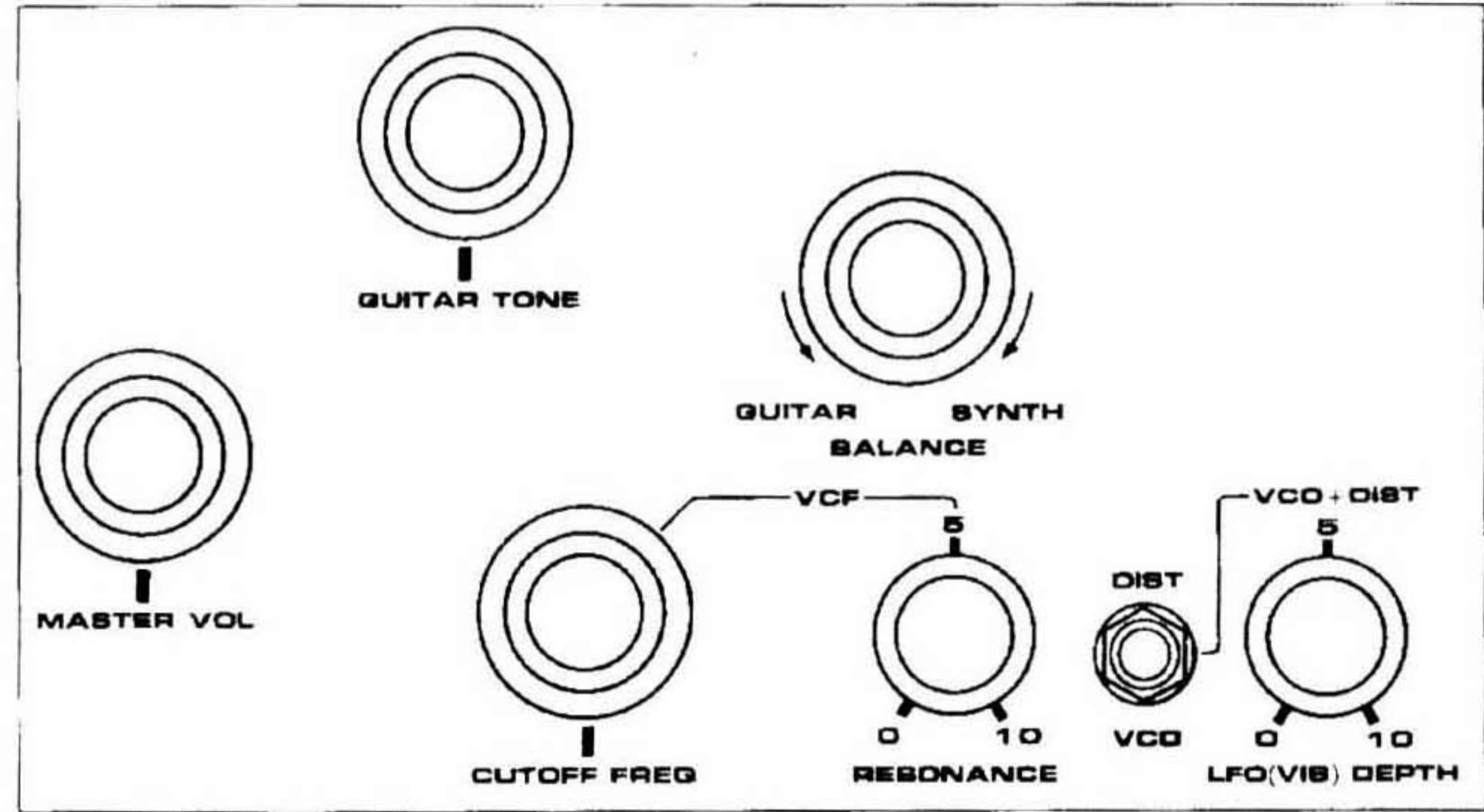

▼GR-300

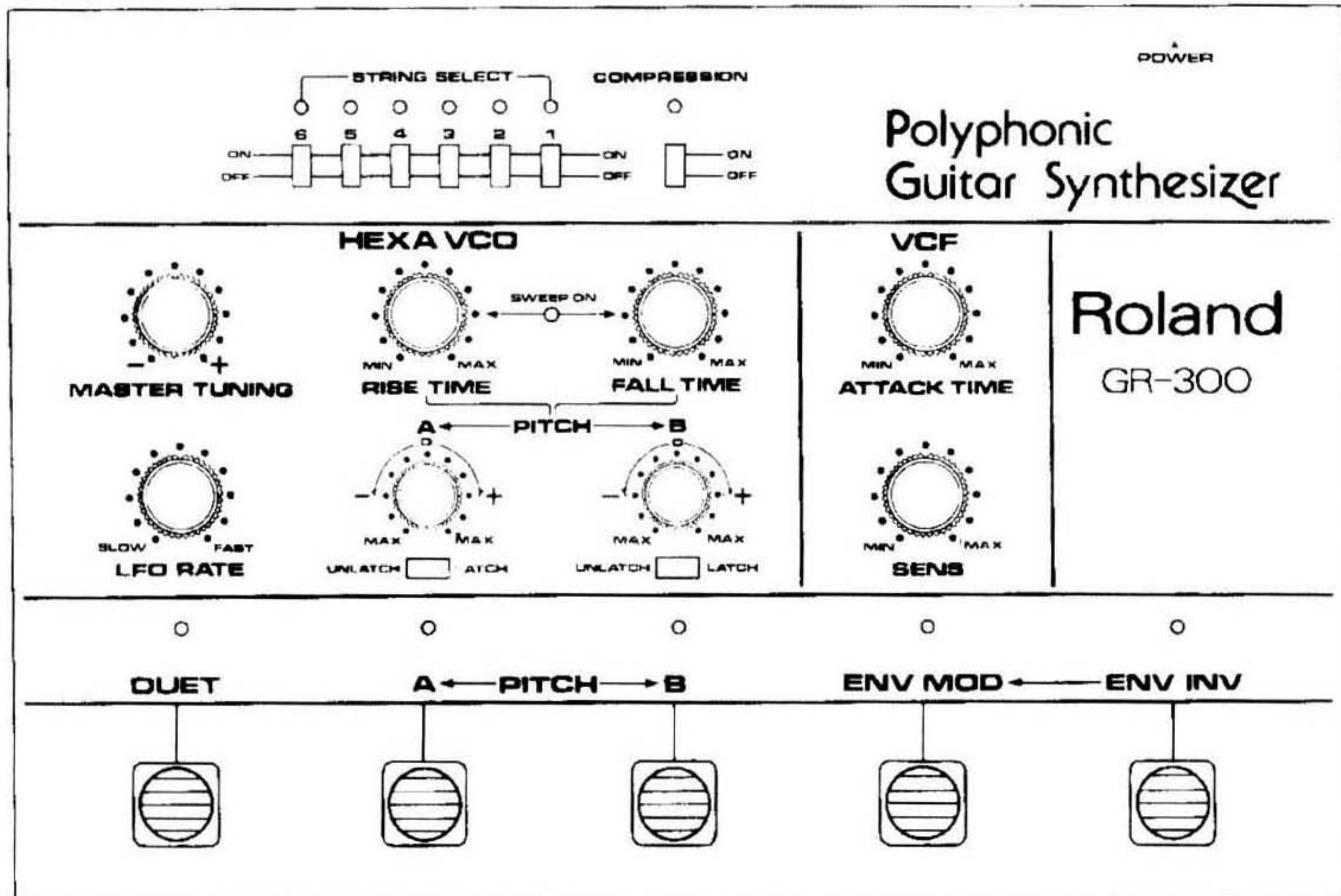

▼GR-300

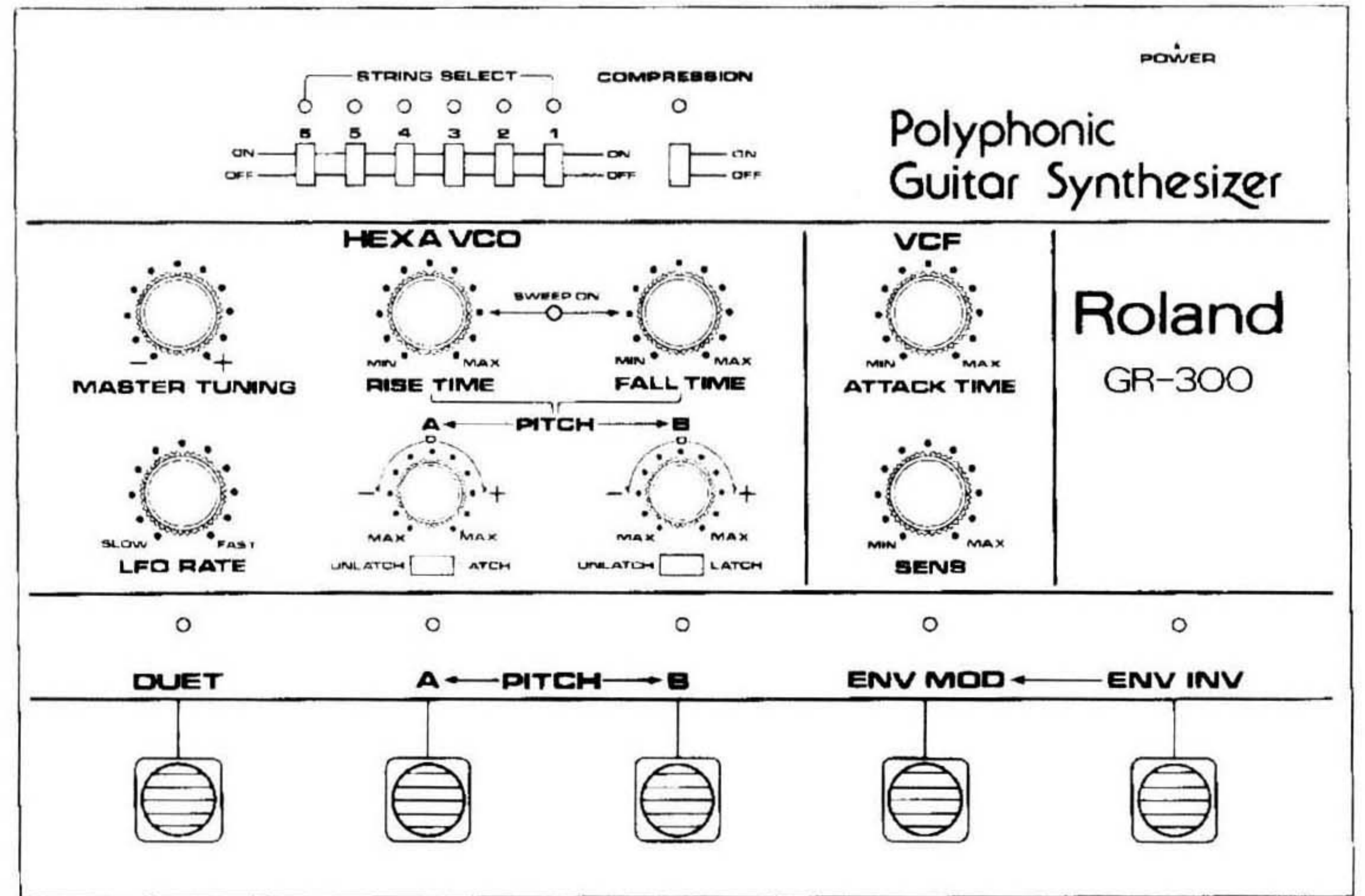

▼G-303/808

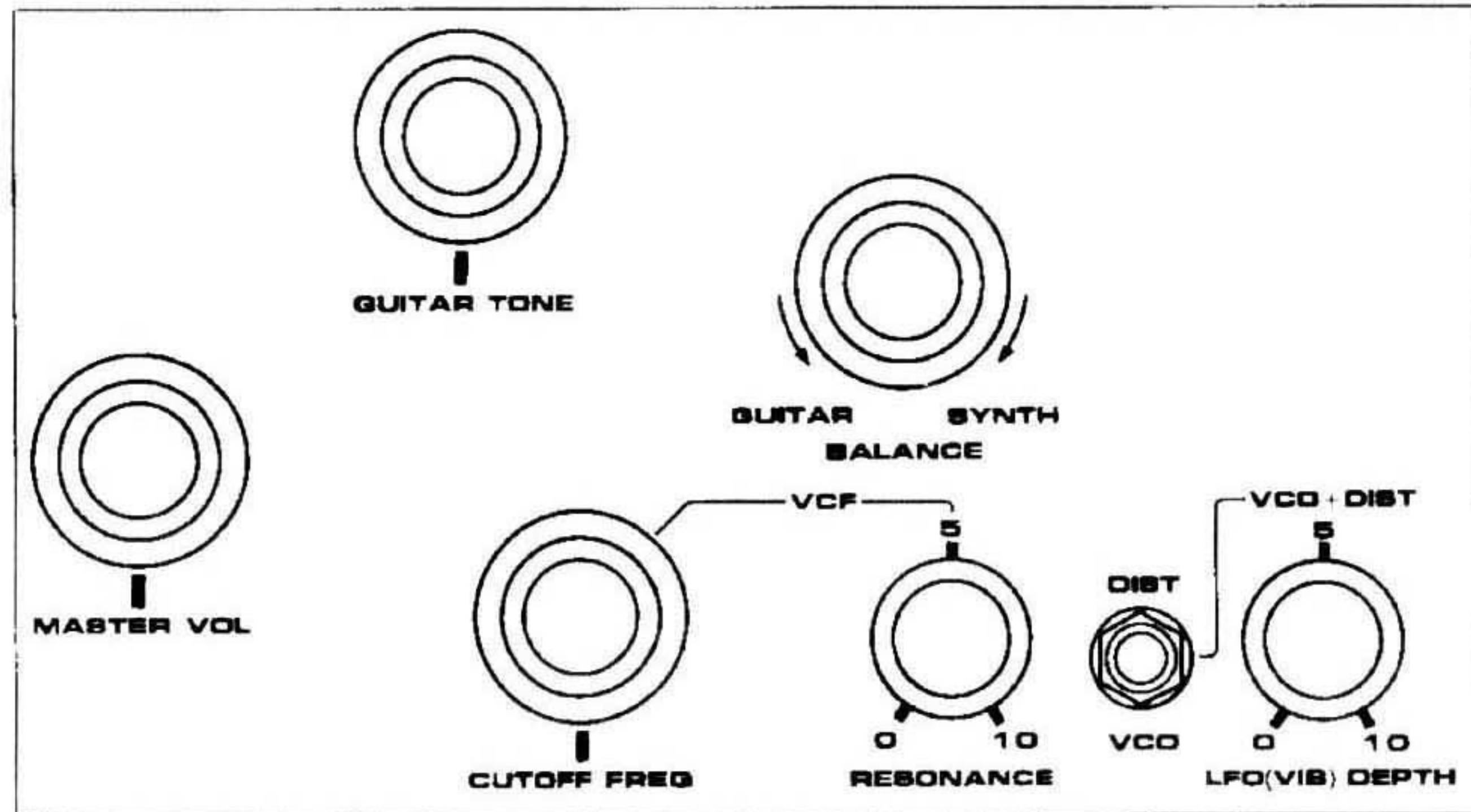

▼G-303/808

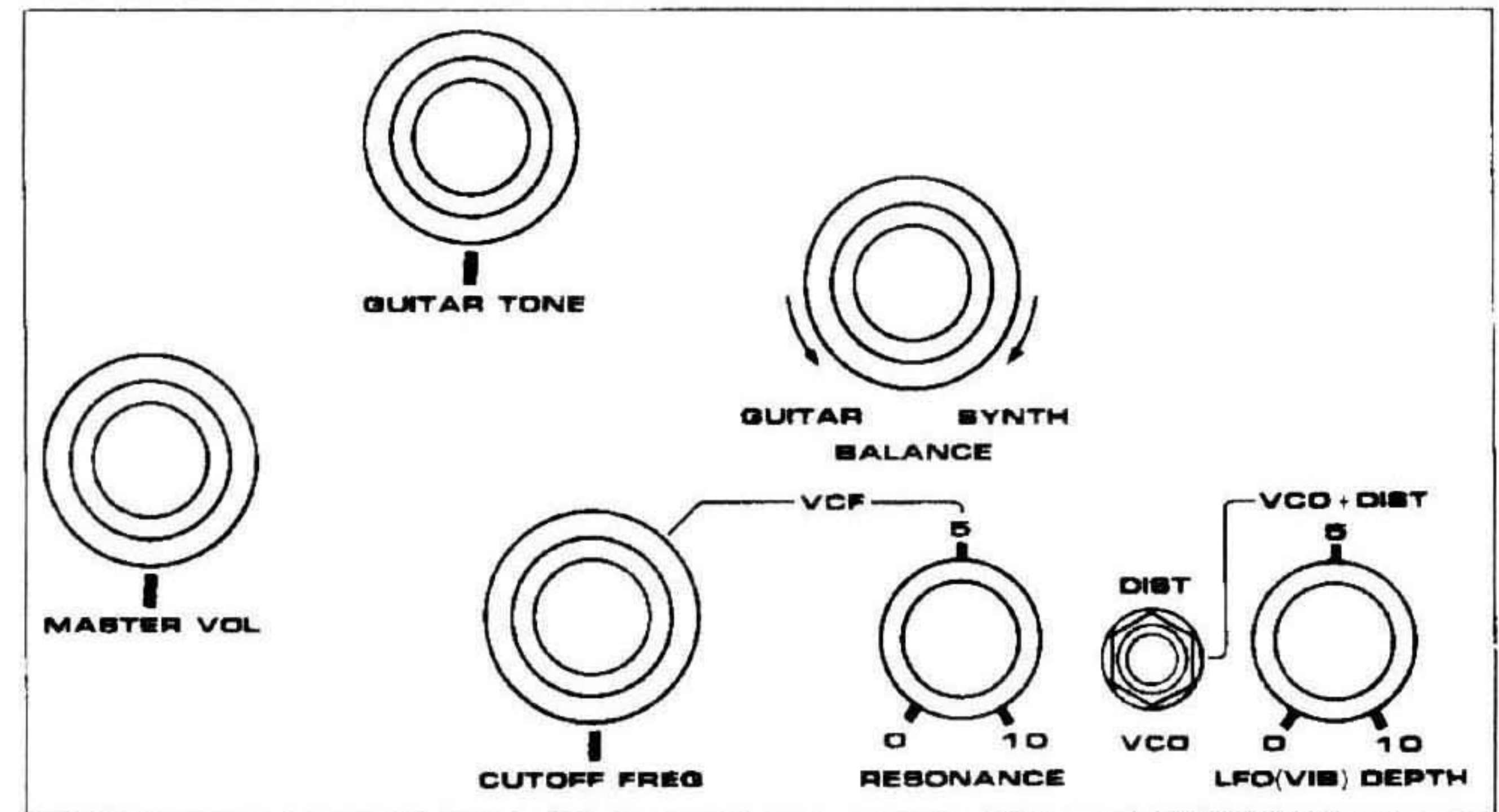

▼GR-300

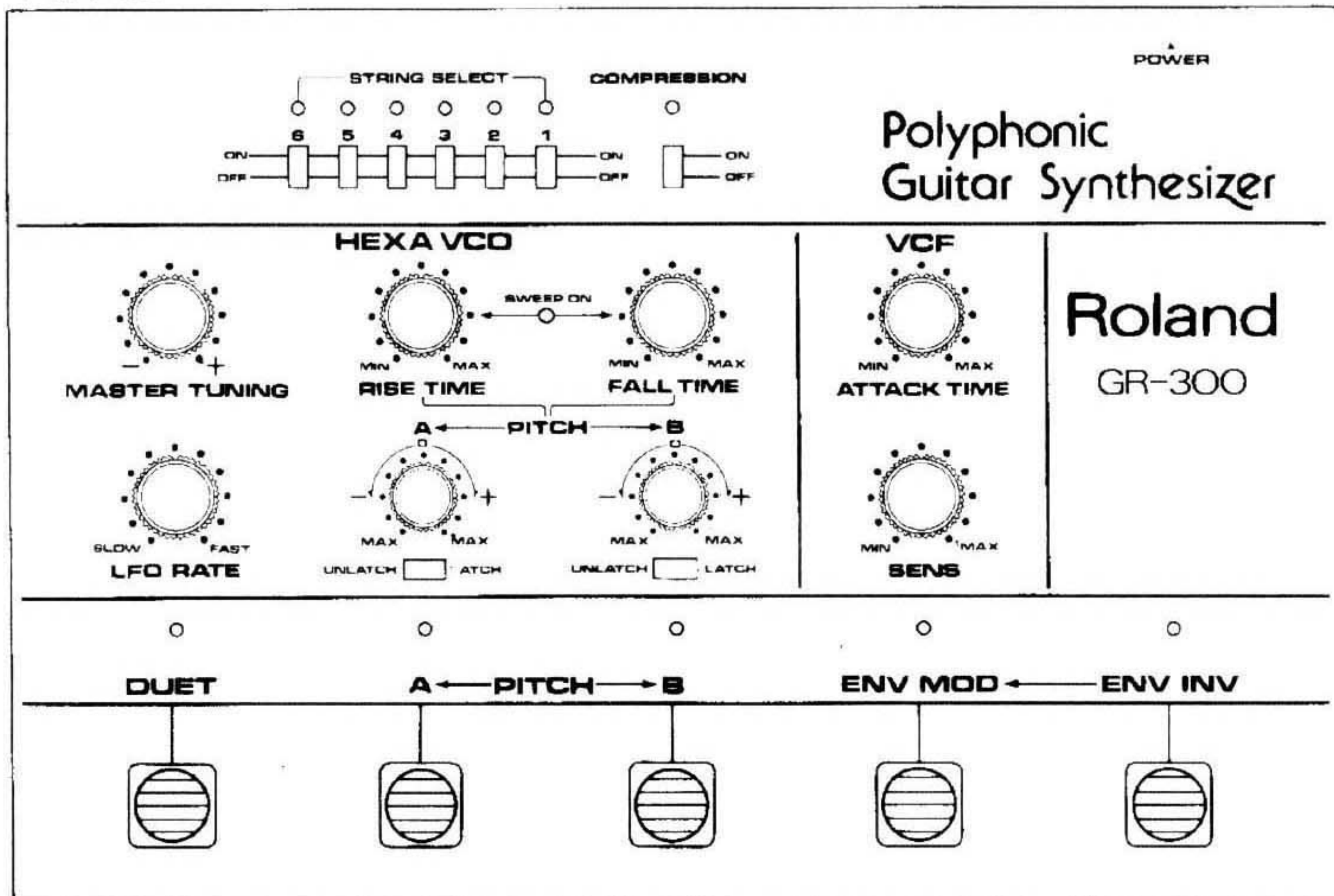

▼GR-300

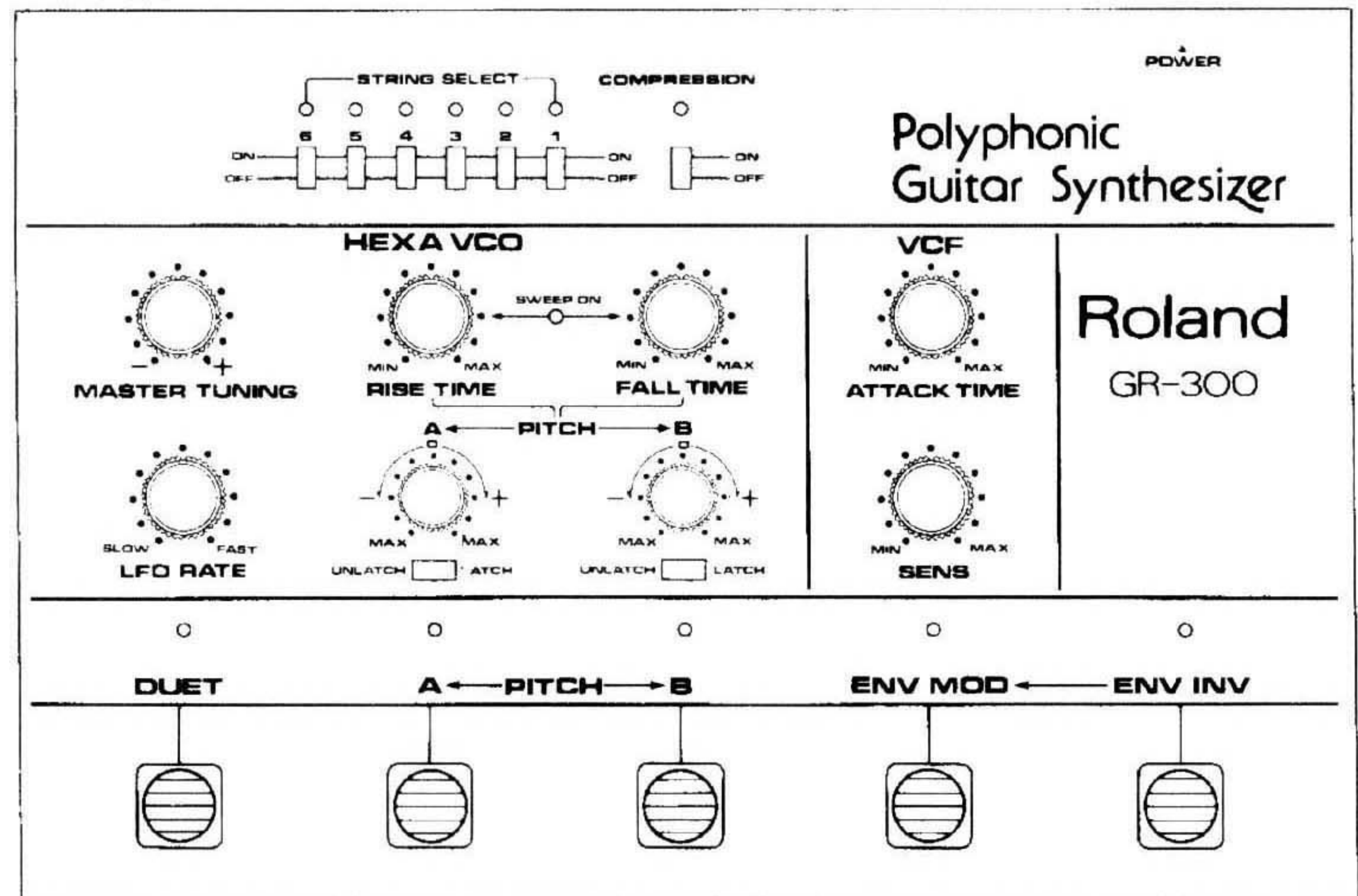

▼G-303/808

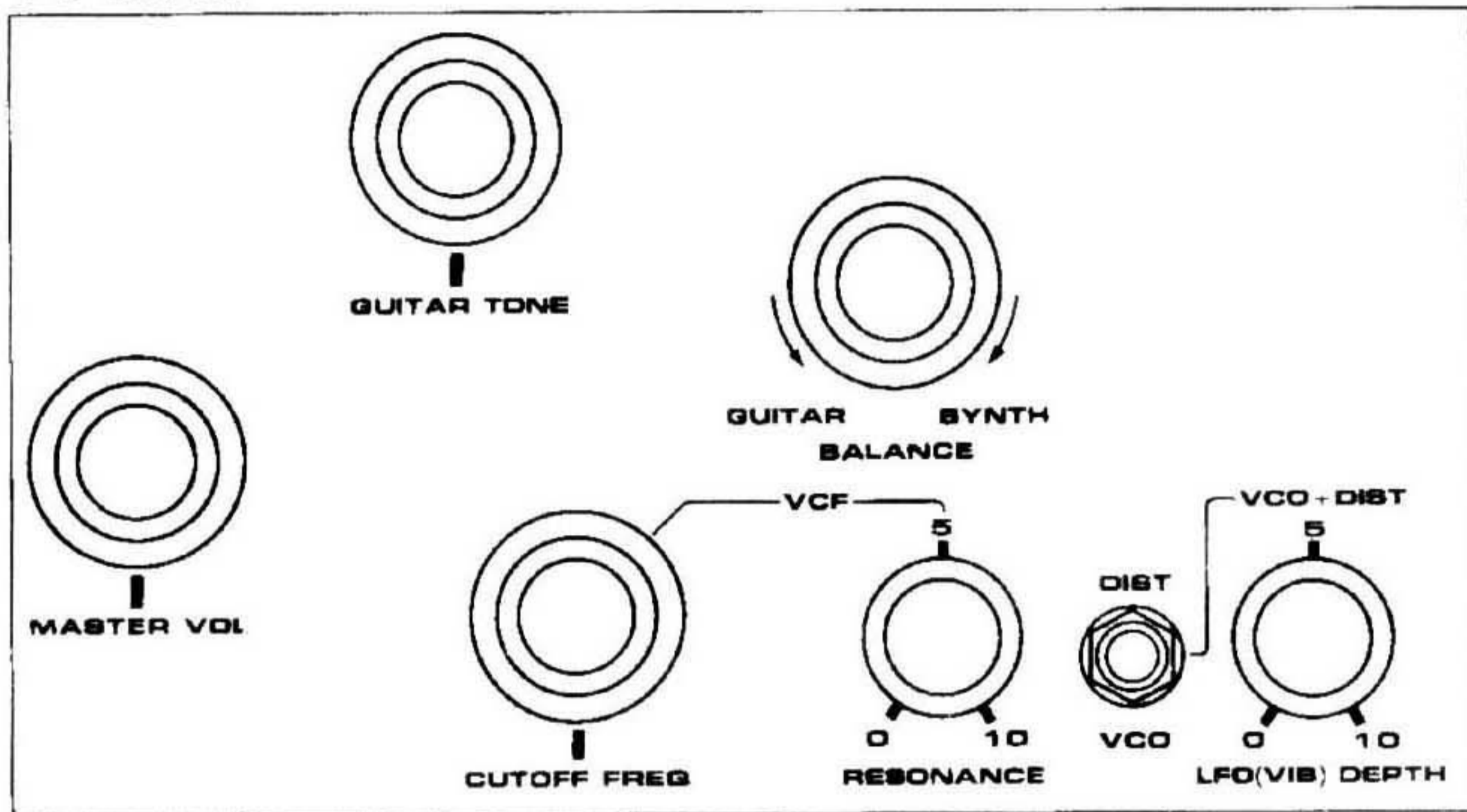

▼G-303/808

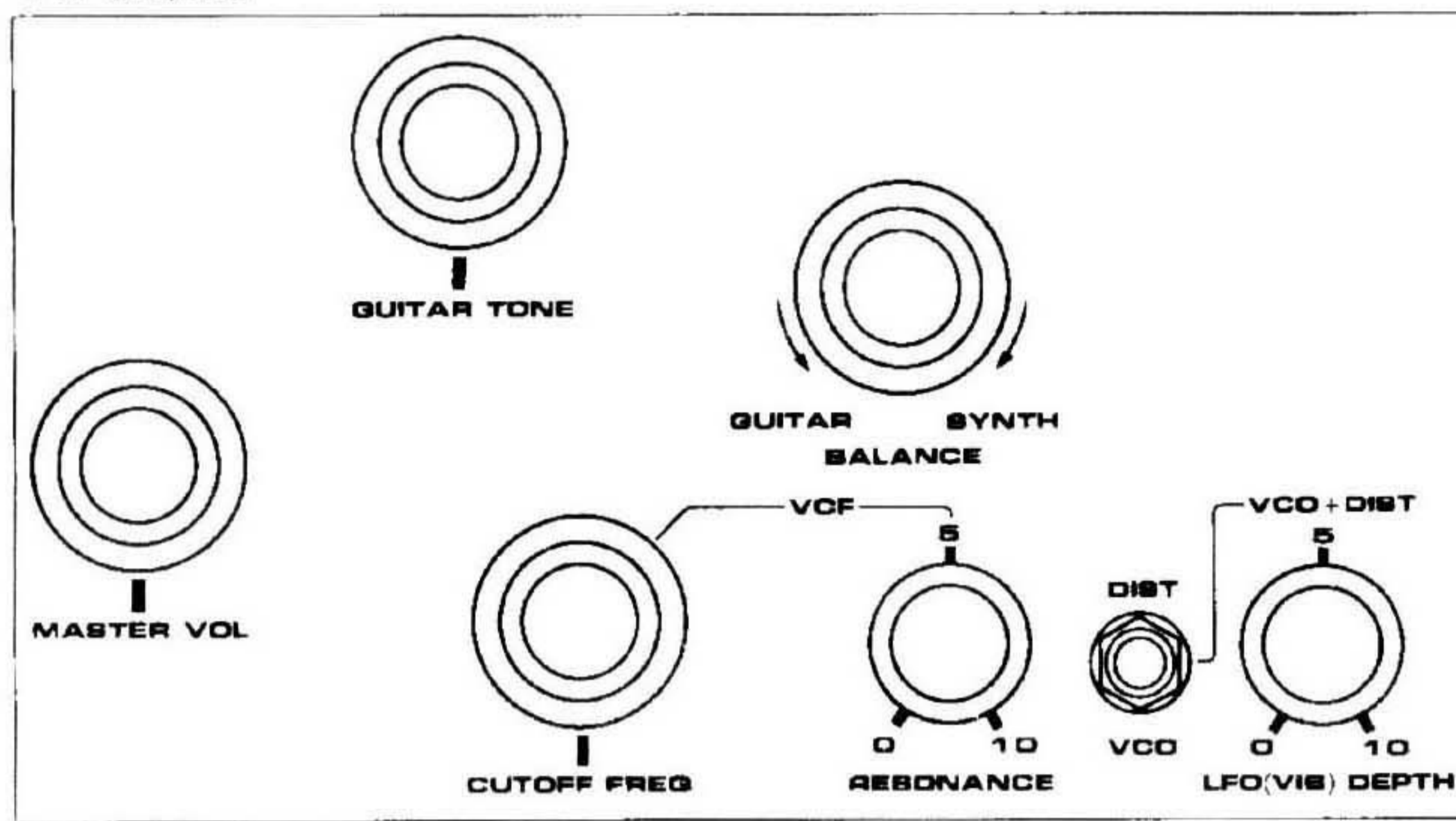

▼GR-300

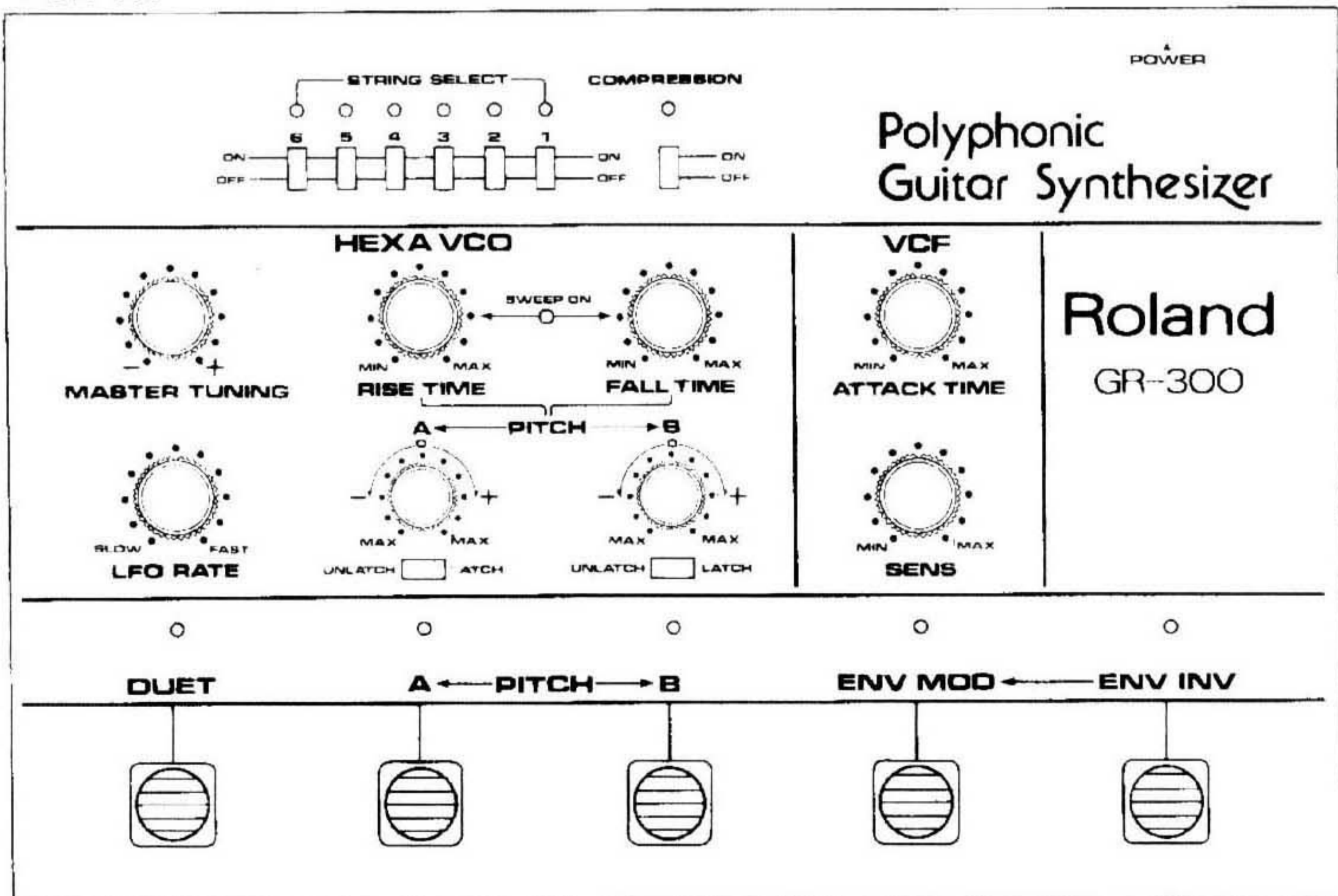

▼GR-300

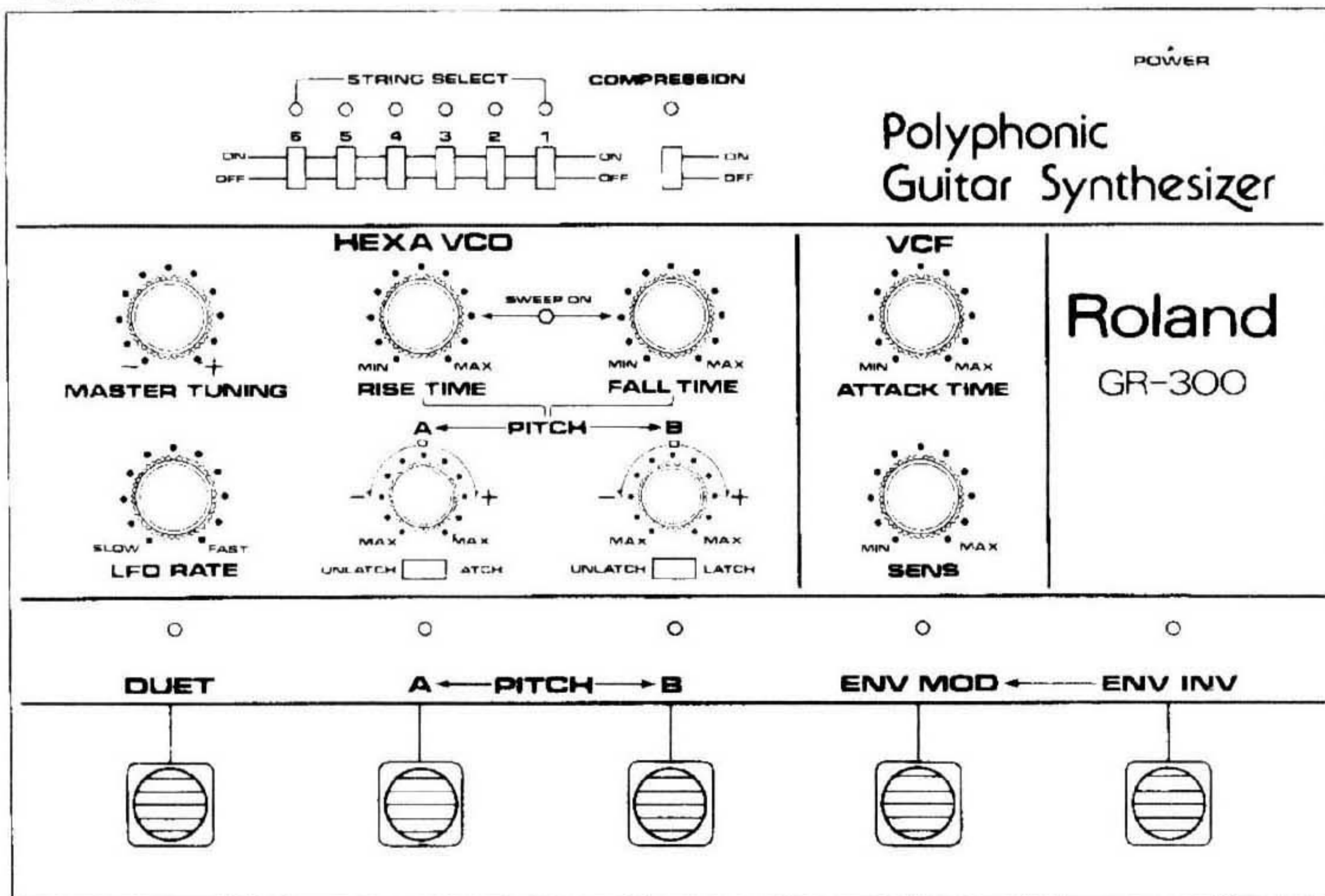

▼G-303/808

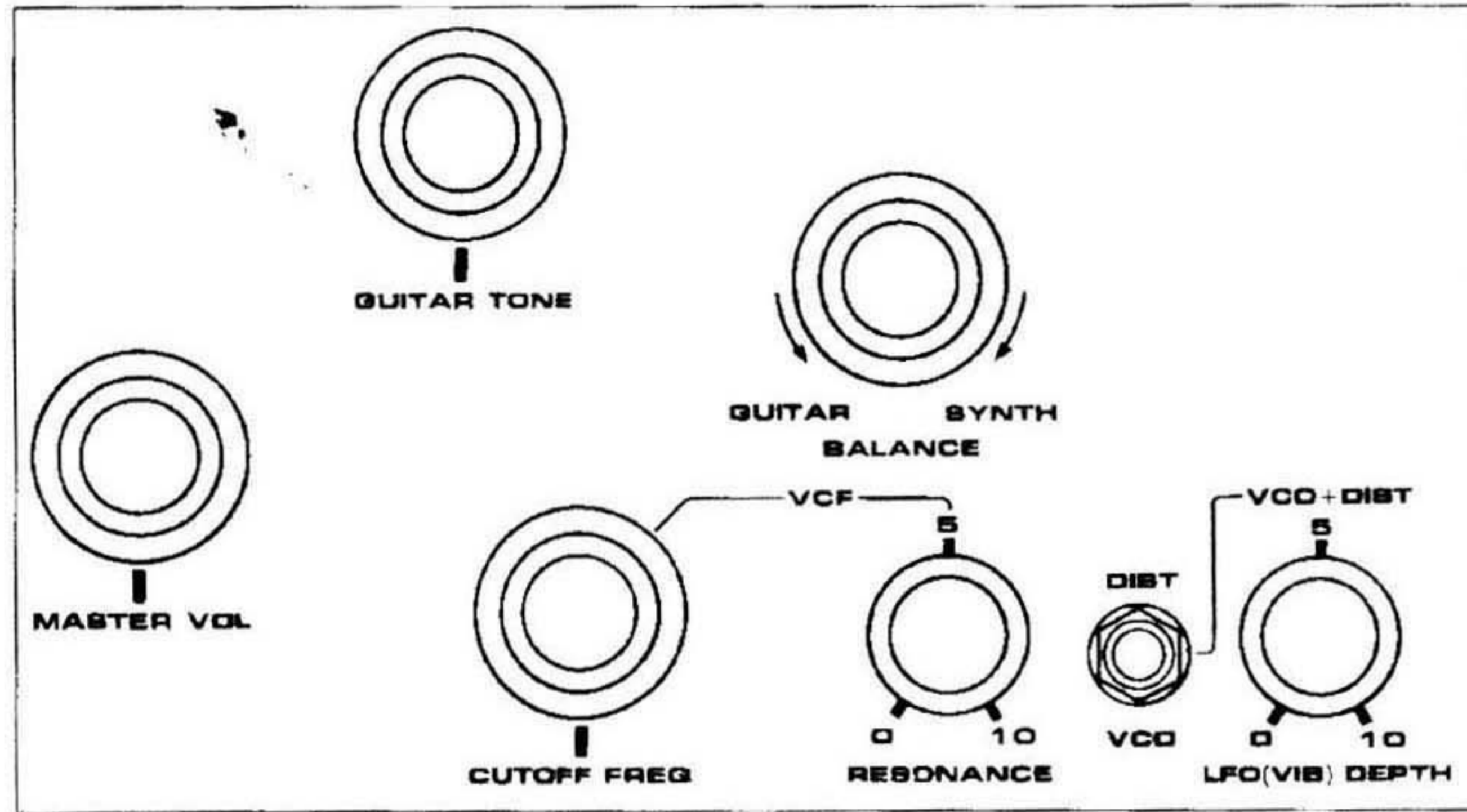

▼G-303/808

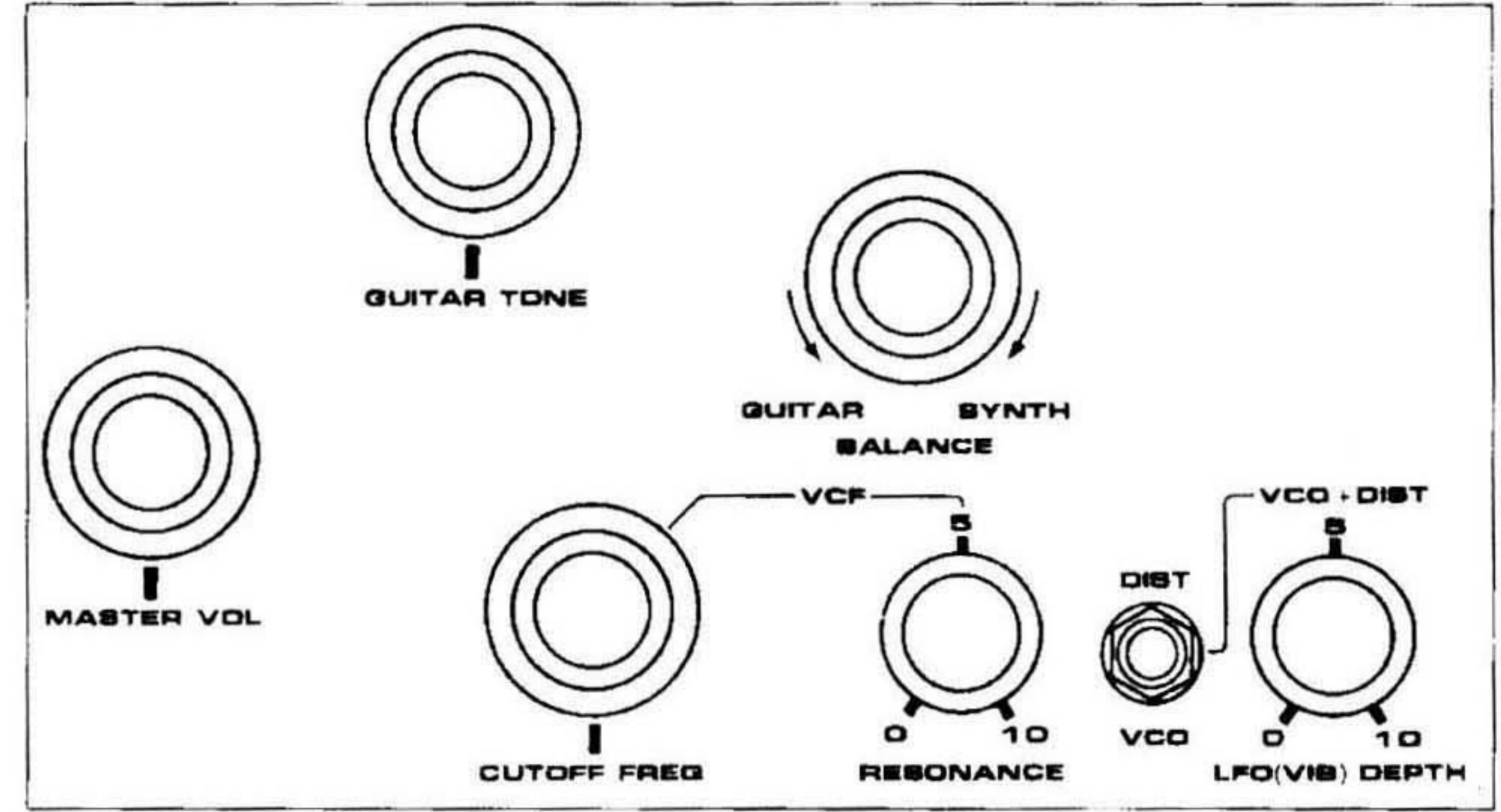

▼GR-300

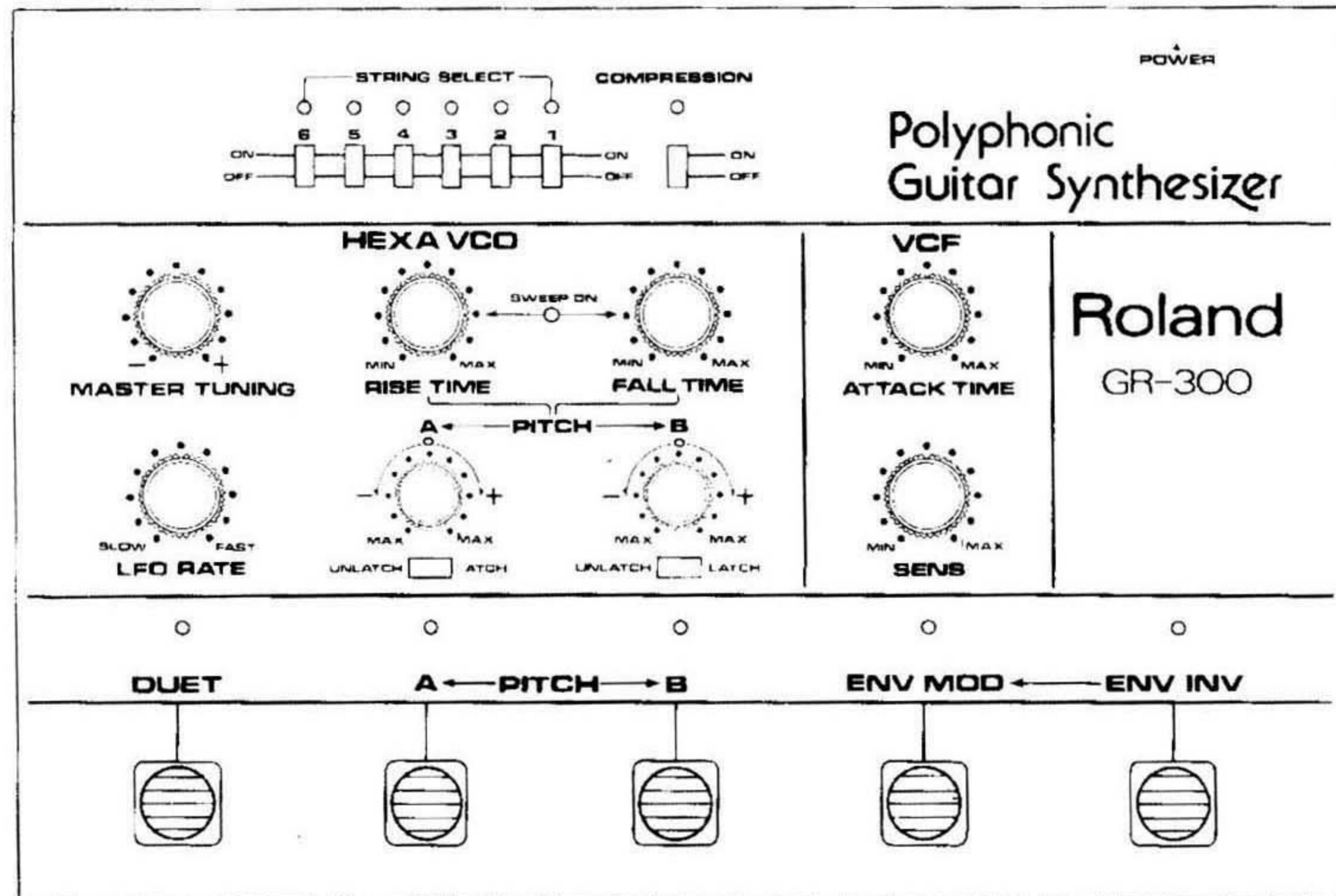

▼GR-300

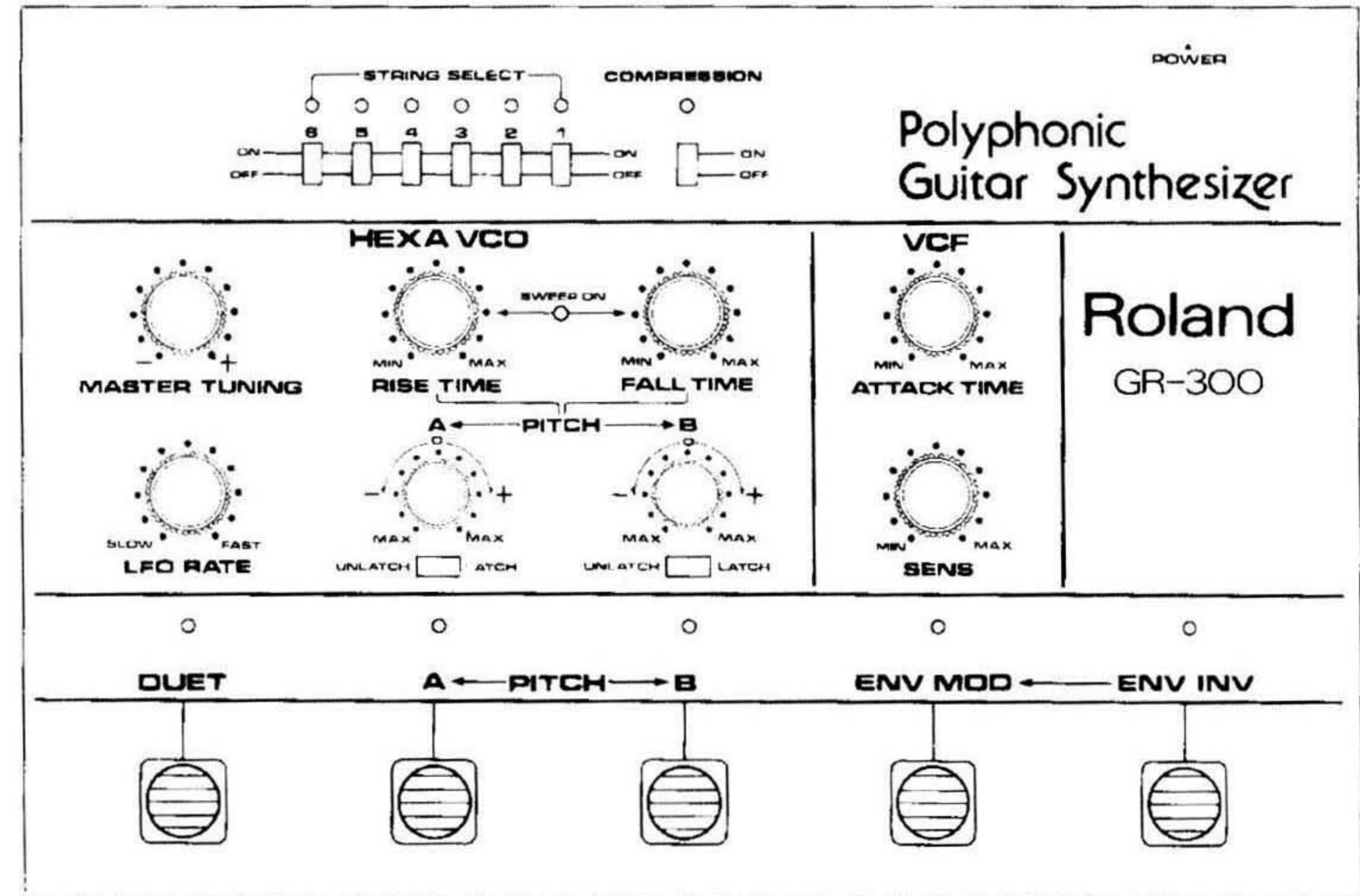

SPECIFICATIONS

HEXA VCO

MASTER TUNING	1
PITCH A (\pm 1300 CENT)	1
PITCH B (\pm 1300 CENT)	1
PITCH LACH/UNLACH SWITCH	2
SWEEP RISE TIME (0-6 SEC)	1
SWEEP FALL TIME (0-6 SEC)	1
LFO RATE (2-10 HZ)	1

VCF

ATTACK TIME (0-2 SEC)	1
MOD SENS	1

VCA

COMPRESSION SWITCH (LONG SUSTAIN)	1
--	---

FOOT SWITCH

DUET	1
PITCH A (PITCH A/OFF SELECT)	1
PITCH B (PITCH B/OFF SELECT)	1
ENV MOD (VCF ENVELOPE MOD)	1
ENV INV (ENV MOD INVERT)	1

STRING SELECT

1-6 SELECT SWITCH	6
STRING INDICATOR	6

EXT FOOT CONTROL

STRING SELECT SWITCH	1
SWEEP ON/OFF	1
VCF PEDAL	1
COMPRESSION SWITCH	1

INPUT

24P CONNECTOR	1
-------------------------	---

OUTPUT

MIX/SYNTH	1
GUITAR	1

POWER REQUIREMENTS	20W
SIZE	400 (W) x 290 (D) x 100 (H) mm
NET WEIGHT	5kg

Roland Corporation